

An Introduction to The Portal to Texas History

Jake Mangum
Project Development Librarian
University of North Texas Libraries
March 4, 2023



<http://texashistory.unt.edu>

The Portal to Texas History



- 2004 ~10K added each month
- 471 collaborative partners 159K+ added last year
- About 1.9 million visible digital objects 1.3+ million uses each month
- 16.8 million files



The Portal to Texas History

- 430,550 photographs
- 877,276 newspaper issues
- 142,995 scripts
- 7,167 books
- 83,750 maps
- 15,109 legislative docs

Overview

2,024,802 Total Items

16,846,558 Total Files

128,577,178 Total Uses

1,910,885 Uses Last 34 Days

Visibility

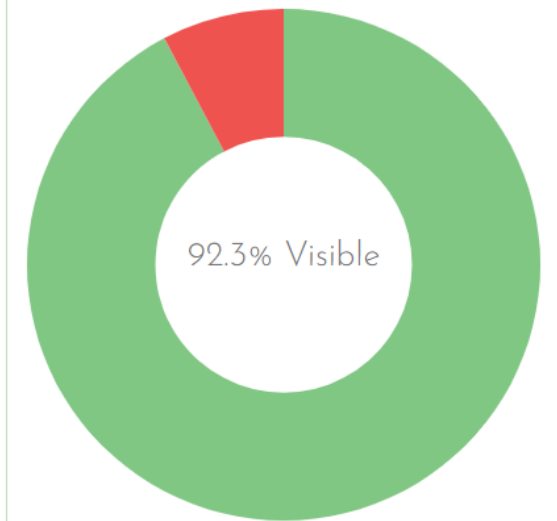

1,869,028 Visible Items

155,774 Hidden Items



Examples of Other Resources in the Portal

- Scrapbooks
- Probate records
- Family letters
- Gammel's Laws of Texas and other state docs
- Genealogical publications, yearbooks, serials
- Course curriculum



The Portal to Texas History

Search 1,869,028 items from 475 partners across Texas.

Any Type ▾

Search

Sample Searches:

"Breckenridge American"

County Courthouse

"Brenham Daily Banner"

"B-24 Liberator"

"Galveston Daily News"

A gateway to rare, historical, and primary source materials from or about Texas.

About the Portal

Search ▾

Explore by ▾

Take a Tour

Donate



re, historical, and primary source materials from on

[About the Portal](#)

[Search](#)



[Explore by](#)



[Take a Tour](#)

[Donate](#)

Explore

[Overview](#)[Collections](#)[Partners](#)[Locations](#)[Subjects](#)[Types](#)[Dates](#)[Titles](#)

Explore Overview

The Portal to Texas History contains more than a half million items for you to explore.

475 Partners	739 Collections	9,226 Titles
37 Resource Types	1,077 Browsable Subjects	71 Decades
1,528 Counties	50 U.S. States	154 Countries

5 days, 22 hours ago
Last Updated

Explore

Overview

Collections

Partners

Locations

Subjects

Types

Dates

Titles

Explore Overview

The Portal to Texas History contains more than

475

Partners

37

Resource Types

Explore Overview

The Portal to Texas History contains more than a half million items for you to explore.

475

Partners

739

Collections

9,226

Titles

37

Resource Types

1,077

Browsable Subjects

71

Decades

1,528

Counties

50

U.S. States

154

Countries

5 days, 22 hours ago

Last Updated

From every corner of Texas

- Museums
- Libraries
- Archives
- Universities
- Publishers
- Private Collectors
- Corporations
- Genealogical Groups
- Historical Societies
- Historical Commissions
- Government Agencies

Explore Locations

Jump to: [Texas Counties \(254\)](#) [U.S. States \(50\)](#) [Countries \(154\)](#)

Texas Counties

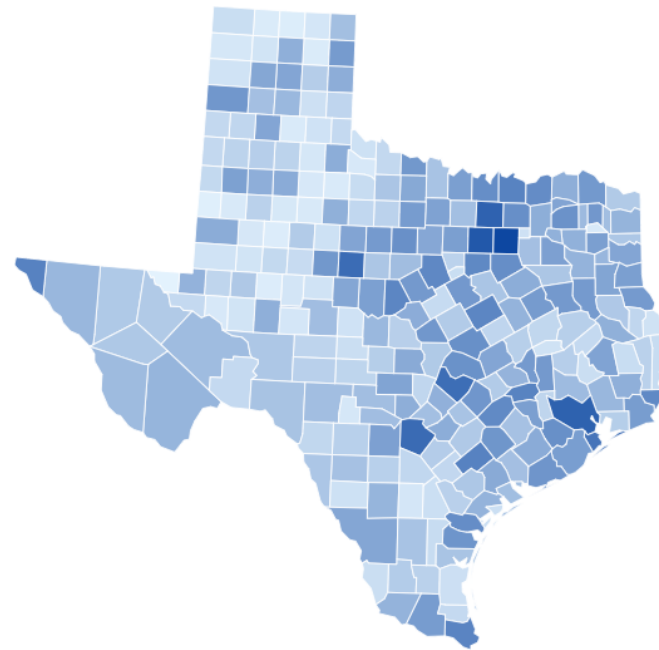

Items available from 254 counties.

Filter Counties

◆ COUNTY NAME	◆ COUNT
Anderson County	8,845 items
Andrews County	470 items
Angelina County	3,592 items
Aransas County	553 items
Archer County	4,806 items
Armstrong County	2,595 items
Atascosa County	749 items
Austin County	6,987 items
Bailey County	721 items
Bandera County	2,087 items



From every corner of Texas

- Museums
- Libraries
- Archives
- Universities
- Publishers
- Private Collectors
- Corporations
- Genealogical Groups
- Historical Societies
- Historical Commissions
- Government Agencies

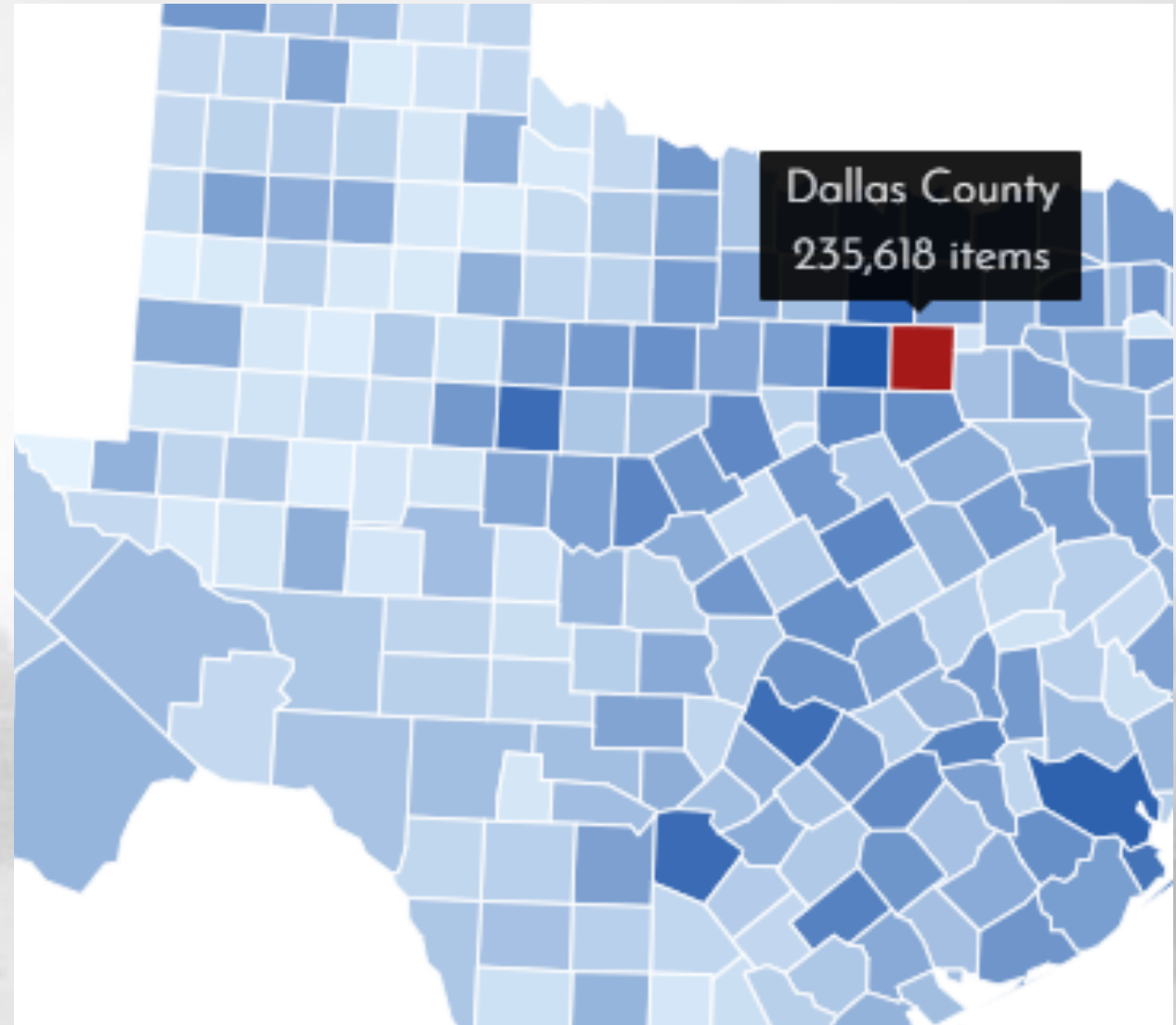

The Portal to Texas History

Search 1,869,028 items from 475 partners across Texas.

Any Type ▾

Search

Sample Searches:

"Breckenridge American"

County Courthouse

"Brenham Daily Banner"

"B-24 Liberator"

"Galveston Daily News"

A gateway to rare, historical, and primary source materials from or about Texas.

About the Portal

Search ▾

Explore by ▾

Take a Tour

Donate

History

Any Type ▼

🔍 Search

ator"

"Galveston Daily News"

History

Any Type

 Search

Everything 

Filter Popular Resource Types

Newspapers 

Photos, Maps, and other Images 

Texts, Books, Documents 

All Resource Types

Articles 

Artworks 

Search Inside

The Portal to Texas History

Home Tour About Explore Search

About This Issue

Overview

Who

What

When

Where

Search Inside

mayor



Matching Results

1

Read Now

Start Reading

Magnify This Page

Jump to...

Go

Show All Pages

12

Print & Share



Citations, Rights, Re-Use

Citing This Issue

Responsibilities of Use

Licensing & Permissions

You Are Here: home / search results / this issue / page: 6

The Caldwell News-Chronicle (Caldwell, Tex.), Vol. 19, No. 14, Ed. 1 Friday, August 19, 1898 Page: 6 of 12

View a full description of this newspaper.

search tools / download zoom

CALDWELL NEWS-CHRONICLE
BEST & JOHNS, Editors and Proprietors.
Issued every Friday at Caldwell, Texas.

TEXAS NEWS NOTES.
Ballinger, Rannels county, has a local option election on.
A fire at Temple destroyed the opera and market houses. Loss, about \$30,000; insurance \$10,000.
The Texas State Single Tax League will hold its annual conference in Galveston, Aug. 24, 25 and 26.
The Houston artillery is assisting the sheriff to guard Payton Burton at Houston, the murderer of the Meyers family at Cypress.
Waco's new postmaster has heretofore been a common dairyman. He now has a bigger and richer test to pull.
Payton Burton, the negro who is charged with the murder of the Meyer family at Cypress a few weeks ago, has been captured and lodged in jail at Houston.
Andrew Carnegie, the iron magnate of Pennsylvania, has sent his check for \$5000 to the mayor of Pittsburg, Texas, to establish a public library in that city.
William Williams has instituted suit in the Travis county district court against the International and Great Northern railroad company for \$5000, for having three tons cut off by a train of that road.
The dead body of Mrs. Mary Houser, whose recent disappearance caused great excitement at Van Alstyne, has been found hanging to a fence post in a secluded spot, where the stretch attracted the searchers. Her apron had been twisted about her neck and tied to the post not over four feet from the ground. No marks of violence.

CROP CONDITIONS.
Gatesville, Coryell County: For several days the weather has been exceedingly hot in day time and cool at night. It is having a tel-

STATE CAPITAL NOTES.
ASSESSMENT REVUE.
Bosque County—Valuation, \$4,606,285, a decrease of \$103,400 over that of last year.
Brazos County—Valuation, \$3,859,985, and increase of \$33,029 over last year.
Ton Green County—Valuation, \$3,789,529, an increase of \$58,634 over last year.
Carson County—Valuation, \$702,855, a decrease of \$121,415 under last year.
Collard County—Valuation, \$3,372,946, an increase of \$78,155 over last year.
Lee County—Valuation, \$2,654,163, a decrease of \$112,784 under last year.
Lee County—Valuation, \$2,982,500, an increase of \$29,880 over last year.
Burnet County—Valuation, \$3,788,116, an increase of \$20,610 over last year.
Hartley County—Valuation, \$1,076,356, an increase of \$86,000 over last year.
Ward County—Valuation, \$953,503, a decrease of \$57,554 under last year.
Wilbarger County—Valuation, \$3,175,137, an increase of \$35,464 over last year.
Reeves County—Valuation, \$2,134,817, a decrease of \$17,178 under last year.
Blanco County—Valuation, \$1,364,157, an increase of \$9872 over last year.
Falls County—Valuation \$8,019,080, decrease \$277,430, under last year.
Collin County—Valuation \$10,920,130, increase \$9,440, over last year.
Himphill County—Valuation \$1,073,088, decrease \$72,864, under last year.
Live Oak County—Valuation \$1,616,065, increase \$2024, over last year.
San Patricio County—Valuation \$1,884,656, decrease \$2024, under last year.
Van Zandt County—Valuation \$3,305,618, decrease \$82,030, under last year.
Hardin County—Valuation \$1,

village incorporated for school purposes and those in the country schools are entitled to as good teachers as those in the cities, and trustees should not be debarred from employing them until the best teachers have been employed.
The decision is looked upon as most important and those here who know are of the opinion that this case will be appealed from the superintendent to the state board of education and in the event that tribunal sustains the superintendent in his opinion the matter will be finally settled in the courts.
The superintendent orders that Mrs. Woods be restored to her full privileges as a teacher in the public schools in the independent school district of Pearsall.
In a lengthy decision this ruling has been sustained by the state board of education.

CHARTERS GRANTED.
Houston Transfer Co.; capital stock \$10,000.
Ahlens Cotton Oil Co.; capital stock \$40,000.
Georgetown Grocery Co.; capital stock \$5,000.
Lieut. Gov. George T. Jester is occupying the governor's chair during Governor Culberson's visit to the Omaha exposition.
Newton county jail bonds to value of \$5500 have been approved and registered.

Cotton Crop Report.
Washington, Aug. 11.—The cotton crop report of the department of agriculture says:
Taking the entire cotton producing region as a unit, the condition of the crop of Aug. 1 was exactly the same as on July 1, namely, 91.2. This 4.3 points higher than on Aug. 1, 1897; 11.1 points higher than on Aug. 1, 1898, and 5.8 points higher than the August average for the last ten years.

YELLOW FEVER APPEARS.
One Death Reported at Franklin and Strict Quarantine at Once.
New Orleans, La., Aug. 12.—Yellow fever has developed at Franklin, La., a small town on the line of the Southern Pacific railroad 100 miles west of this city.
Last night John Hobson died under peculiar conditions and the parish physician held an autopsy, resulting in the verdict of yellow fever. The man had been treated for meningitis by the local physicians.
Upon learning of the nature of the disease the Southern Pacific trains loaded to the platforms and many of the residents left the town. The body was buried at once and the premises where he was sick were disinfected.
The Louisiana state board of health at once declared quarantine against Franklin and so did all the neighboring towns. The people of the neighborhood placed pickets around Franklin.
Report is Confirmed.
Austin, Tex., Aug. 13.—Dr. Blunt, the new state health officer, got into the harness quick. He has already located an alleged case or death from yellow fever at Franklin, La., a town 100 miles this side of New Orleans on the Texas and New Orleans railroad. In response to a telegram from Beaumont making inquiries Dr. Blunt wired as follows:
"Report of death from fever at Franklin confirmed."
NEW HEALTH OFFICER.
Dr. Blunt of Lockhart Succeeds the Late Dr. Swearingen.
Austin, Aug. 12.—Gov. Culberson has appointed Dr. W. F. Blunt of Lockhart state health officer, vice Dr. R. M. Swearingen, deceased.
Dr. Blunt was connected with the health department of the state from 1875 to 1897, most of the time was a quarantine officer at Galveston, where he gave great satisfaction and which position he voluntarily resigned about two years ago and returned to Lockhart, his old home. He is an in-

MORMONISM IN TEXAS.
The State Division Into Three Colonies, and Many Others.
This account of the Latter Day Saints appears in the Dallas News. According to a statement made in Dallas not long since by an elder of the church there are about 500 converts to the faith of the Latter Day Saints in this state. These converts are divided into six colonies, which are governed by church officers.
One of these colonies is in Dallas county. It is situated on Mountain creek about eight miles west of this city, and boasts of a membership of about twenty-five. It is said that it was established about a year ago, and that its members are prosperous and happy. The children of the colony attend Sunday-school just the same as other children do, and the grown folks go to church and to prayer-meeting. The meeting house, or church, which is at present used by them, possesses an advantage which is not possessed by the most palatial temple of worship in Dallas—it is cool and pleasant. Under the shade of tall, spreading trees, in a quiet little corner, an enormous arbor has been erected, covered with vines and the home of song birds, it makes an ideal place for worship during the summer months. During week days every member of the colony works from sunrise until sunset. Men, women and children toil the living day. The rule that there must be no safeguards in this human hive is inflexible. It is the policy of this church to send its missionaries into every state in the Union. These missionaries are very zealous. They frequently make a house to house canvass of large cities for recruits. Every nook and cranny is visited. When a sufficient number of converts has been secured, they are formed into a colony and an officer of the church is placed in charge. This officer is quite an important personage, for the government of a Mormon colony by the church is



Types of Partnerships



Museum Collections: Weslaco Museum

Weslaco Annual Fashion Show

Dorothy Carlisk. Her dress is made out of 1000 acalpa leaves. The purse is overlaid with ground alfalfa. The jerkin is made of rows of the scarlet bracts of the poinsettia plant.



HOWARD WILEY
EGGPLANT

Weslaco Annual Fashion Show

Claricia Balli is wearing a suit made of shattered green fern. The lapels and her purse are made of mums and the hat and shoes are of the fern trimmed in mums.



Public Library Collections: Dallas Public Library

WATERS PIERCE OIL COMPANY
High-Grade Cylinder Machine Oils
205-207 MAIN ST. DALLAS

A. Watkin Music Co.
STEINWAY, FISCHER AND OTHER PIANOS
GUITARS, VIOLINS, STRINGS, SHEET MUSIC, ETC.

REINHARDT & SON
(SIDNEY REINHARDT)
GENERAL AGENTS
ALL KINDS OF

ADOLPHUS AUTO RENT CO. BOTH PHONES Main 5257

FINE Pianos and Player-Pianos SHEET MUSIC

BUSH & GERTS PIANO CO. Bush Temple of Music 1311-13 ELM ST.

The Star Cash Stores Co.

WE SELL FOR LESS

34 Stores in Dallas: One in Your Neighborhood

THE THIEL DETECTIVE SERVICE COMPANY

BEAUTIFUL *Lake Cliff*
CLEAN, COOL, DELIGHTFUL.
THE SOUTHWEST'S GREATEST PLAYGROUND
ITS IN DALLAS.



Guide To
Texas Emigrants.
1835.

DALLAS
POLICE DEPARTMENT

SOUTHLAND LIFE INSURANCE COMPANY
Over One Billion Dollars Insurance in Force
Offers You Complete Protection Through
LIFE • ACCIDENT • HEALTH • HOSPITALIZATION • GROUP

MACATEE, INC.
DEPENDABLE BUILDING MATERIALS
ROOFING—FLOORING—ACOUSTICAL

SPOTLIGHTING
the south's finest banking facilities

REPUBLIC NATIONAL BANK of Dallas

For Envelopes of Distinction
CALL **THESE** ENVELOPE COMPANY

OTTO COERVER CO., INC.
STORE FIXTURES — BANK FIXTURES — SHOW CASES

limepod
FIRST CHECK-LOAN ACCOUNT

More Than 20 Millions in Assets For Our Policyholders
PLANNED LIFE INSURANCE PROTECTION

1st NATIONAL
The Southwest's Leading Bank!
FIRST NATIONAL BANK
IN DALLAS

REPUBLIC INSURANCE COMPANY
1903—FORTY YEARS OLD—1943
"Largest and Strongest Stock Fire Insurance Company Domiciled in the South"

GREAT SOUTHERN LIFE INSURANCE COMPANY
LIFE INSURANCE CONTRACTS TO FIT EVERY NEED

INSURANCE EMPLOYERS CASUALTY COMPANY

1811 ROSS AVE. PHONE C-9277
ED. C. SMITH & BRO. UNDERTAKING CO.
ESTABLISHED 1876

1st NATIONAL
The Southwest's Leading Bank!
FIRST NATIONAL BANK
IN DALLAS

REPUBLIC INSURANCE COMPANY
A. F. PILLET, President • Cash Capital \$2,000,000 • DALLAS, TEXAS
1903—THIRTY-EIGHT YEARS OLD—1941
"Largest and Strongest Stock Fire Insurance Company Domiciled in the South"

GREAT SOUTHERN LIFE INSURANCE COMPANY
LIFE INSURANCE CONTRACTS TO FIT EVERY NEED

INSURANCE EMPLOYERS CASUALTY COMPANY

SHAW'S
NATIONALLY ADVERTISED JEWELRY
1618 MAIN ST.

1st NATIONAL
The Southwest's Leading Bank!
FIRST NATIONAL BANK
IN DALLAS

REPUBLIC INSURANCE COMPANY
A. F. PILLET, President • Cash Capital \$2,000,000 • DALLAS, TEXAS
1903—OVER A THIRD OF A CENTURY OLD—1937
"Largest and Strongest Stock Fire Insurance Company Domiciled in the South"

GREAT SOUTHERN LIFE INSURANCE COMPANY
LIFE INSURANCE CONTRACTS TO FIT EVERY NEED

INSURANCE EMPLOYERS CASUALTY COMPANY

SHAW'S
NATIONALLY ADVERTISED JEWELRY
1618 MAIN ST.

1st NATIONAL
The Southwest's Leading Bank!
FIRST NATIONAL BANK
IN DALLAS

REPUBLIC INSURANCE COMPANY
A. F. PILLET, President • Cash Capital \$2,000,000 • DALLAS, TEXAS
1903—OVER A THIRD OF A CENTURY OLD—1937
"Largest and Strongest Stock Fire Insurance Company Domiciled in the South"

GREAT SOUTHERN LIFE INSURANCE COMPANY
LIFE INSURANCE CONTRACTS TO FIT EVERY NEED

INSURANCE EMPLOYERS CASUALTY COMPANY

Organization Collections: Lockheed Martin Aeronautics Company, Fort Worth

Two Days Left to Get Insurance Without Physical
April First Deadline On Group Plan

Published every other Wednesday by Consolidated Value Aeronaut Corp.
 For the benefit of Convair policyholders.

Convairiety
 FORT WORTH EDITION
 COMMUNITY 3-RING CIRCUS

SAN DIEGO, CALIF. | DAINSBURG, TEX. | FT. WORTH, TEX.
 Vol. 3, No. 7 | Wednesday, March 29, 1966

XB-36 Tries Tracked Landing Gear
 Caterpillar Principle Put in Use

The page 8 for special conditions and correct wiring giving information about Group Insurance.

of these new studies of machine...
 NEW WRINKLE—These are first photos released showing new tracked landing gear...
Cohu Examines Convair Accomplishments in 49
 Following a statement by LaRocca T. Coak, Convair president and general manager...
Convair FW Gives Red Cross \$18,000, Tops Quota 150 Pct.
Turboprop Future Bright, Says Keller
HIGH WIRE BEAUTY—Angela Kern, Gainesville, Tex., is...
Editor's Note: The AERO Club campaign...
Editor's Note: The AERO Club campaign...
Editor's Note: The AERO Club campaign...

DIRECTIONS

LOCKHEED

Tribe Travels New Road
 Chosen eating...
Book Details War in Israel
 LM author...
Virtual Programming Enters New Areas with CATIA V5
 An F/A-22...
Employees on Roll
 Convair...
Aeronautics Star
F/A-22 evolving into world's dominant
First Raptor training squadron stands up at
LM AERO Club surpasses goal; campaign chairman says thanks
New Year's One company

Published every other Wednesday by Consolidated Value Aeronaut Corp.
 For the benefit of Convair policyholders.

Convairiety
 FORT WORTH EDITION
 COMMUNITY 3-RING CIRCUS

SAN DIEGO, CALIF. | DAINSBURG, TEX. | FT. WORTH, TEX.
 Vol. 3, No. 4 | Wednesday, February 15, 1966

New Paycheck Plan to Replace Plant Funds Campaigns
'Florida Winter' Ice Experience For B-36
Search for Son Ends at Convair
Suggestion Plan Awards Climb
Delay of Five Years Costs FW Man a Job
Paul Tax Receipts for Plant Top 1,500
CRA Moves Into New Home at FW Open House Celebration Planned



Private Collection of T.B. Willis

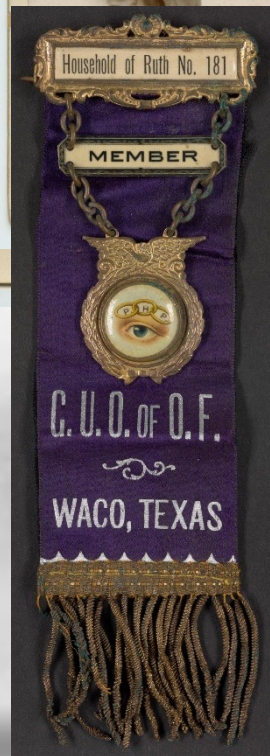
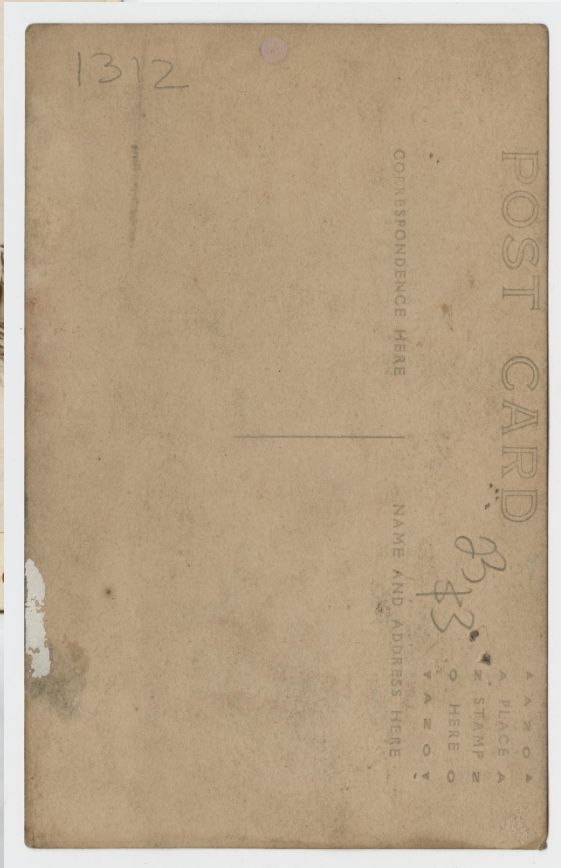

Academic Library Collections: Dallas County Community College District



Governmental Collections: Dallas Municipal Archives

An Act to incorporate the city of Dallas, in Dallas County, Texas.

Section 1. Be it enacted by the Legislature of the State of Texas, That all the inhabitants of the city of Dallas shall be a body politic and corporate, by the name and style of the "City of Dallas," and as such, by that name, they and their successors shall be known in law, and be capable of contracting and being contracted with, of suing and being sued, and defending in all courts, and all actions, and matters whatsoever, every person and whole and some personal property, and dispose of the same for the benefit of the said city, and every house and acre in corporate debt, and other and change the name of the same.

Section 2. That the form and name of the said corporation shall be as follows, to-wit: Beginning at a point on the east corner of the Trinity River, at low water mark, directly opposite to the corner of the West Texas Express, running thence east parallel with Trinity Street, one and one-half miles, thence north parallel with Jeff Davis Street, three-fourths of one mile, thence west parallel with Trinity Street to same Trinity river, thence down same river with the meanderings thereof to the point of beginning, thence east along the low first described, one and one-half miles, thence north parallel with Jeff Davis Street, three-fourths of one mile, thence west parallel with Trinity Street, one and one-half miles, to same Trinity river, thence south the meanderings thereof to the point of beginning, provided that the same limits of said corporation may be further extended by adding additional territory to the same whenever the majority of the inhabitants of said territory shall so require.

REPORT NO. 4

Filed in my office this the
5 day of July 1955
Frank B. Shook
City Secretary, Dallas

**REPORT ON EDUCATION
for
COMMUNITY IMPROVEMENT**

**DALLAS ACTION COMMITTEE
for
COMMUNITY IMPROVEMENT**

ER, 1964

HOUSING ASSISTANCE PLAN



for the
city of
Dallas
1955

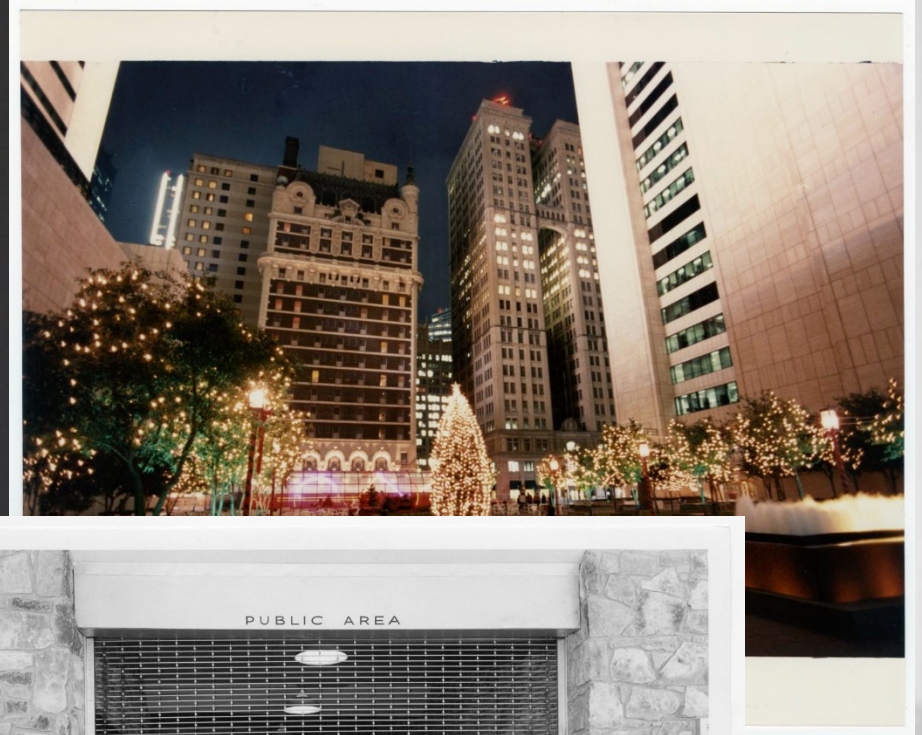

**CHARTER
OF THE
CITY OF DALLAS**

1907



Genealogical and Historical Collections: Dallas Genealogical Society

Dallas County, Texas
 Probate Cases
 1846 – Early 1900's

Case Number 1

Dallas Genealogical Society
 Founded 1955

www.dallasgenealogy.org

The Dallas Journal

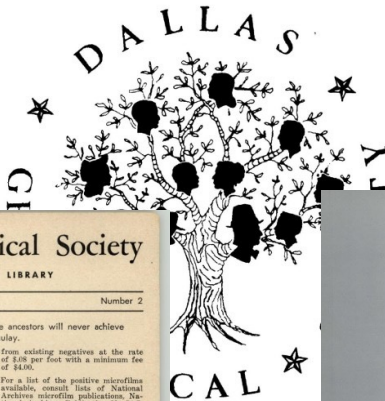

Local History & Genealogical Society
 COOPERATING WITH THE DALLAS PUBLIC LIBRARY

Volume 1 MARCH 23, 1955 Number 2

OUR CREED: "A people which takes no pride in the noble achievements of remote ancestors will never achieve anything worthy to be remembered with pride by remote descendants." — LORD Macaulay.

NEW BOOKS IN THE DALLAS PUBLIC LIBRARY

- Mrs. Margaret Pratt, Head of the Texas, Local History and Genealogy Department of the Dallas Public Library, has reported that the following new books have been received by the Library and are now available for use by the public.
- New Jersey Archives — Five volumes of Wills (1760-1817).
- Cotton, J. B. — Maryland Wills, Vols. 8 and 9.
- Pennsylvania Colonial Records — Vols. 6, 7, 9, 10, 11, 12, 14, 15.
- Pennsylvania Archives — Third Series, 30 Vols.
- Crozier — Virginia Colonial Militia.
- Crozier — Early Virginia Marriages.
- Crozier — Williamsburg Wills.
- Vermont Marriages — Vol. 1.

STATE CENSUS

The Bureau of the Census has published a document containing a bibliography of all census records taken by States after the year 1790.

The publication lists in alphabetical order a description of the information contained in each census and the name and address of the person to write, if information is desired from such census. It further advises whether or not any fee is charged and the amount thereof.

For instance, anyone desiring a name search in the 1810 or 1820 Census of the State of Illinois may write to the Trustees of the Illinois State Historical Library and obtain a reply without charge.

A copy of the publication by the Bureau of Census is in the possession of the Society. Copies may be obtained by writing the Superintendent of Documents, United States Government Printing Office, Washington 25, D. C., for the charge of \$20. The publication has no number. The description given above will be sufficient for identification.

FIRST METHODIST CHURCH CEDAR HILL, TEXAS

All of the existing records of the First Methodist Church, Cedar Hill, have been obtained by the Society and are now in the possession of the President.

The Church is one of the oldest in Dallas County, having been established before 1870. The first entry in the existing records is in 1874.

NATIONAL ARCHIVE RECORDS WASHINGTON, D. C.

Costs of records may be minimized by obtaining microfilm of records on file with the National Archives and Records Service, Washington, D. C. A new schedule of rates has been published, and a copy is in the possession of our Society.

Sample costs are as follows:
 Positive microfilm may be obtained

SURNAMES UNDER SEARCH

Persons in Dallas, Texas, are searching for information regarding the following families. Those wishing to exchange information should contact the person at the address listed:

CHAMBERS — Pennsylvania, Virginia, Georgia and Texas
 Mr. W. Early Chambers
 Drawer 83
 Sanger, Texas

PEGASUS
 Journal of the Dallas Genealogical Society

PREMIERE ISSUE 2013
 VOLUME 1, NUMBER 1

Donated by Renee Smith

DALLAS GENEALOGICAL SOCIETY
 A Texas Non-profit Corporation
 Dallas, Texas

Formerly the Local History and Genealogical Society

December 1976
 Issue No. 4

NEW NAME. Have you noticed? We have a new name. The name, "DALLAS GENEALOGICAL SOCIETY," was selected by the membership at the November general meeting. This is a good start for the new year.

NEW EXECUTIVE VICE PRESIDENT. To go with our new name, we also have a new Executive Vice President — Bob Johnston. He is already into plans for the May workshop which will again be held at the North Park Inn on May 7, 1977. Mr. Johnston is interested in suggestions for topics or themes for the workshop. He has also asked if the membership would be interested in a two-day workshop on Saturday and Sunday instead of just a Saturday workshop. Your comments would be appreciated.

SMOKING AT GENERAL MEETING. The Board discussed the taking of a smoking vote by the membership at the October meeting and reached a consensus that the action of the meeting is not enforceable. It was decided that we would follow the practice of the City Ordinance and have tables for smokers and tables for non-smokers.

life for so many years that some folks feel that a meal is and to give up that pleasure for them would be a true recalling their first smoke "behind the barn" remembers a bout of displeasure — some describing the aftermath with watery eyes, and even nausea. Some non-smokers develop a presence of tobacco smoke today.

ation of our meeting room and other factors, your consent that you please restrict your smoking in the meeting at

BIOGRAPHICAL HISTORY OF DALLAS COUNTY, TEXAS. The "Biographical History of Dallas County, Texas," was increased on December 1. This will be \$39.50 for the purchase of age. You can save the postage fee, plus wear and tear on it up from Dave Arant, Minnie Chany, or Bob Swann. The number of books through the mail. Unfortunately, nothing shuffling of mail and ultimate damage to articles. So yourself, if possible.

when your are to be submitted as soon as possible. I return it to the Treasurer, Mrs. Ed P. Trickett.

----- DALLAS GENEALOGICAL SOCIETY -----
 Date Dues Received: _____
 Amount of Dues: _____

MEMBERSHIP. Members of the Dallas Genealogical Society are the "Quarterly," per year. This service was recently being offered to the membership.



Lesser Known Resources



☰ Explore This Patent

hide

About This Patent ▸

Overview

Who

What

When

Where

Search Inside ▾

mangum



Matching Results

2

View Now ▾

Print & Share ▾

Citations, Rights, Re-Use ▾

back to search results

Mud Scraper.

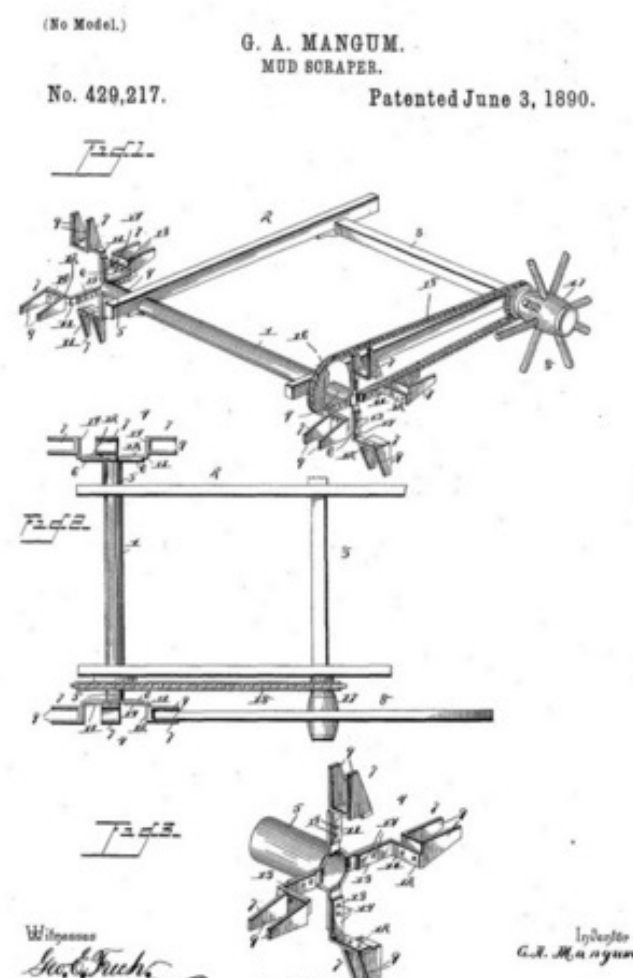

Description

Patent for a new and improved mud-scraper. This design consists, "with a vehicle, of the transverse shaft geared to one of the wheels and provided at one of its ends with spiders, having its arms provided with perforations, the approximately U-shaped scrapers arranged to straddle the wheel, and the L-shaped plates or knees having one arm secured to a scraper and the other arm provided with perforations adjustably connected to the spider" (lines 88-102).

Physical Description

[2], 1 p. : ill. ; 23 cm.

Creation Information

Mangum, George A. June 3, 1890.

Context

This **patent** is part of the collection entitled: [Texas Patents](#) and was provided by [UNT Libraries Government Documents Department](#) to [The Portal to Texas History](#), a digital repository hosted by the [UNT Libraries](#). More information about this patent can be viewed [here](#).

hide

Mud Scraper.

(No Model.)

G. A. MANGUM.
MUD SCRAPER.

No. 429,217.

Patented June 3, 1890.

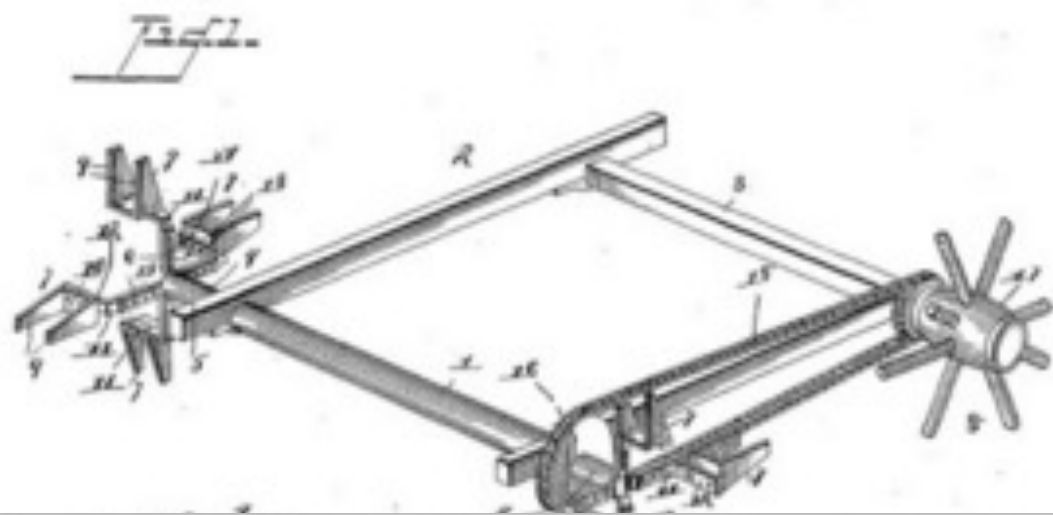

Description

Patent for a
"with a vehic
and provided
provided wit
arranged to
having one o
with perforat
102).

Physical De

City Directories

CHARLES B. GRABE, MERCHANT TAILOR
608 MAIN STREET

ROBERTSON & WITTEN, FUNERAL DIRECTORS
EMBALMING A SPECIALTY.
Telephone and Telegraph Orders Receive Prompt Attention.
806 HOUSTON STREET, FORT WORTH.

B. H. BECKHAM,
DEALER IN WOOD, COAL AND GRAIN
OFFICE AND YARDS:
614 THROCKMORTON ST., JUNCTION MONROE.

TEXAS BREWING CO.,
BREWERS AND BOTTLERS OF PURE LAGER BEER
AND MANUFACTURERS OF ICE.
Telephone: 1 OFFICE, 20-222 MAIN ST., FORT WORTH, TEXAS
PATRONIZE HOME INDUSTRY.

FORT WORTH Steam Laundry
PROMPT, NEAT AND RELIABLE.
WORK CALLED FOR AND DELIVERED.
W. H. LENNON, Mgr. J. F. LENNON, Pro.
N. W. Cor. W. Daggert Ave. and Lipscomb St.
PHONE 201.

HEATON, BURY & CO. Real Estate and Loan Brokers

J. ADD WHITESIDE ATTORNEY 103 1/2 W. Weatherford PHONE LAMAR 3991

FARMERS & MECHANICAL NATIONAL BANK SEVENTH AND MAIN STS.
OF FORT WORTH
\$300,000 SURPLUS \$300,000

P. ROBERTSON FUNERAL DIRECTOR
EMBALMING A SPECIALTY { 308-310-312-314 WEST TENTH ST. OPPOSITE CITY HALL }
Telephone Orders Receive Prompt Attention PHONE LAMAR 29, 2

STAW BROS.
CREAM AND ICE PRODUCTS
Coal and Wood
PHONE LAMAR 1359 PHONE LAMAR 21

OLD STORAGE
Reinforced Concrete, Cork Insulation
On G. C. & S. F. Railroad Tracks.
Capacity 250 Cars Get Rates
Texas Brewing Co.

Phone Lamar 8 Service, Satisfaction Security

FARMER'S BUSINESS COLLEGE F. A. FARMER, President Phone Lamar 1096
MRS. F. A. FARMER, Secy. Mitchell-Greer Bldg.

C. W. CHILDRESS & CO. (758) FIRE INSURANCE

L. P. ROBERTSON FUNERAL DIRECTOR
EMBALMING A SPECIALTY. TELEPHONE AND TELEGRAPH ORDERS RECEIVE PROMPT ATTENTION.
806 HOUSTON ST., FORT WORTH.

THE FORT WORTH REAL ESTATE CO. 510 1/2 HOUSTON ST. PHONE 807
N. R. TISDAL, GEN'L Mgr.
CHOICE FARMS RANCHES AND CITY PROPERTY

T. M. BROWN & CO. DEALERS IN
WIND MILLS, PUMPS
TANKS, IRON PIPES, FITTINGS, HEAVY HARDWARE,
Wholesale Plumbers and Water Supply Materials. 1008, STEEL AND BRASS GOODS.
CORNER FRONT AND CALHOUN STREETS, FORT WORTH.

TEXAS BREWING CO.'S CROWN BOTTLE BEER
TO BE HAD IN EVERY FIRST-CLASS ESTABLISHMENT.

HEATON, BURY & CO. (Victoria Bldg.) REAL ESTATE AND LOANS

C. W. CHILDRESS & CO. (COR. 7TH AND HOUSTON) DRUGGISTS
L. P. ROBERTSON. THOS. WITTEN.

L. B. WEINMAN ARCHITECT OFFICE OVER 711 MAIN

WITTEN, DIRECTORS
A SPECIALTY.
Orders Receive Prompt Attention.
RETY. - FORT WORTH.

WITTEN, STORE
CLOTHING, HATS, SHOES, GROCERIES, FURNITURE, PAINTS, OILS, GLASS, ETC.

WITTEN BROS. PUMPS
WIND MILLS, ETC.

WITTEN & CO. FURNITURE
FURNITURE, PAINTS, OILS, GLASS, ETC.

WITTEN & CO. ARCHITECT

WHITESIDE ATTORNEY 215 1/2 MAIN PHONE LAMAR 3991

ERS & MECHANICAL NATIONAL BANK SEVENTH & MAIN STS.
OF FORT WORTH
\$0,000 SURPLUS \$300,000

ROBERTSON FUNERAL DIRECTOR
SPECIALTY: 308-310-312-314 WEST TENTH ST. OPPOSITE CITY HALL
E LAMAR 29 RES., ROSEDALE 316

STAW BROS.
CREAM AND ICE PRODUCTS
PHONE LAMAR 1359 PHONE LAMAR 21

OLD STORAGE
FIREPROOF
Modern, Reinforced Concrete, Cork Insulation
On G. C. & S. F. Railroad Tracks.
CAPACITY 250 CARS GET RATES
TEXAS BREWING CO.
PHONE LAMAR 8 Service, Satisfaction, Security

Southwestern Engraving Company ENGRAVERS, J. I. WALDEN, MANAGER PHONE LAMAR 2673
Main & 14th

National Business College F. A. FARMER, President THOS. F. A. FARMER, Secretary
MITCHELL-GREER BUILDING PHONE LAMAR 7079



Search by Maps

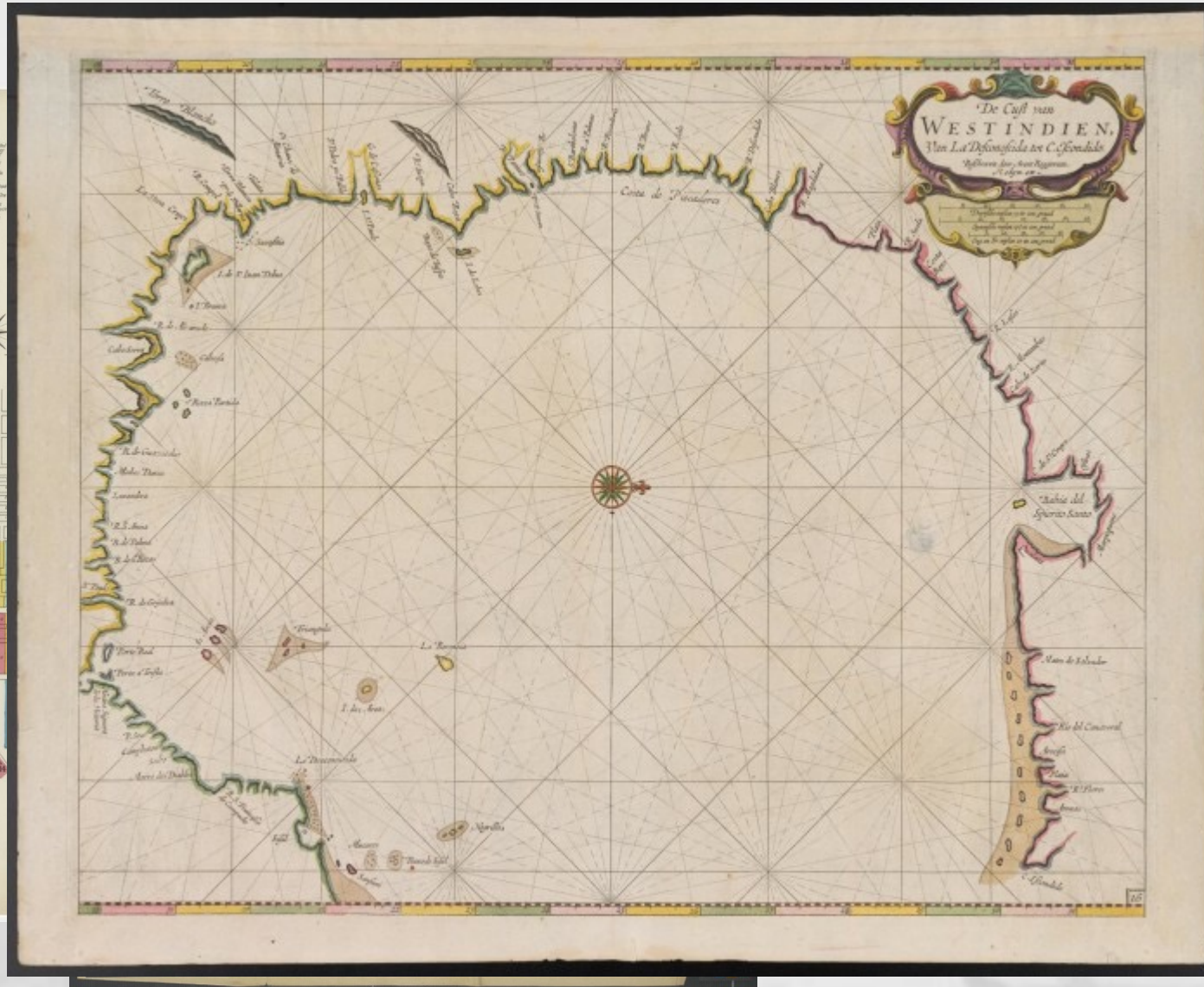
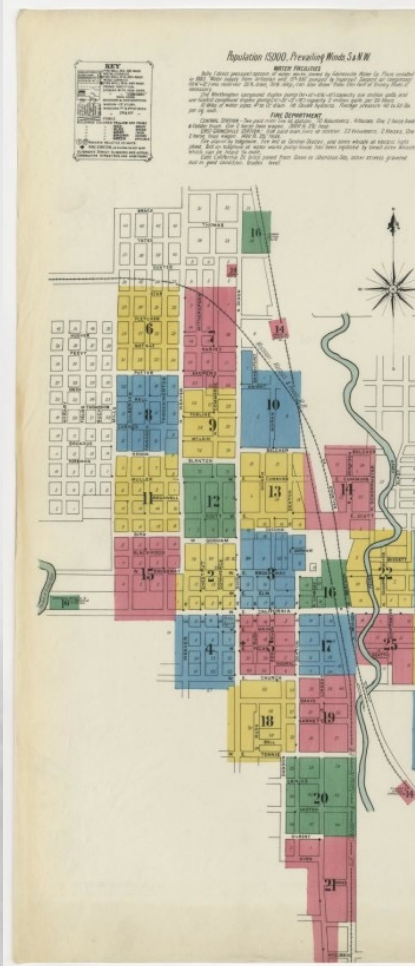

Gammel's Law

- Hans Peter Mareus Neilsen Gammel
- 31 Volumes
- Early colonization laws
- Proceedings from constitutional conventions
- All laws and resolutions passed from every congressional and legislative session from statehood to 1897

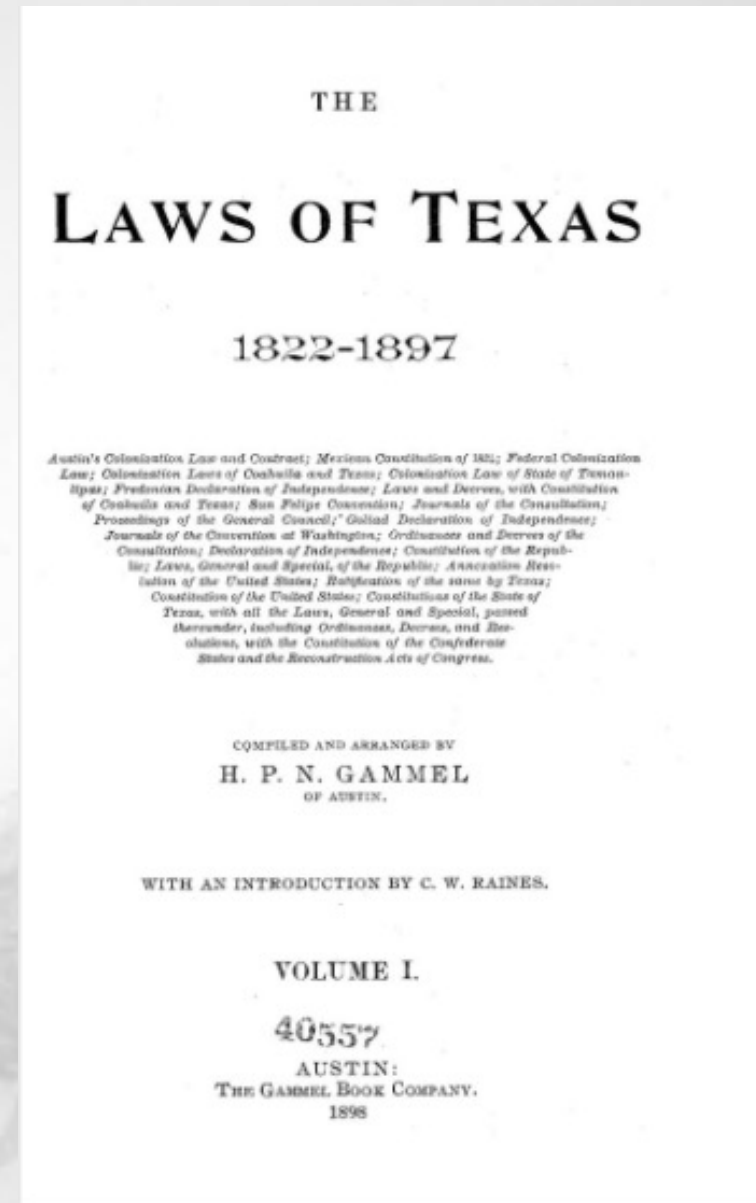

Yearbooks

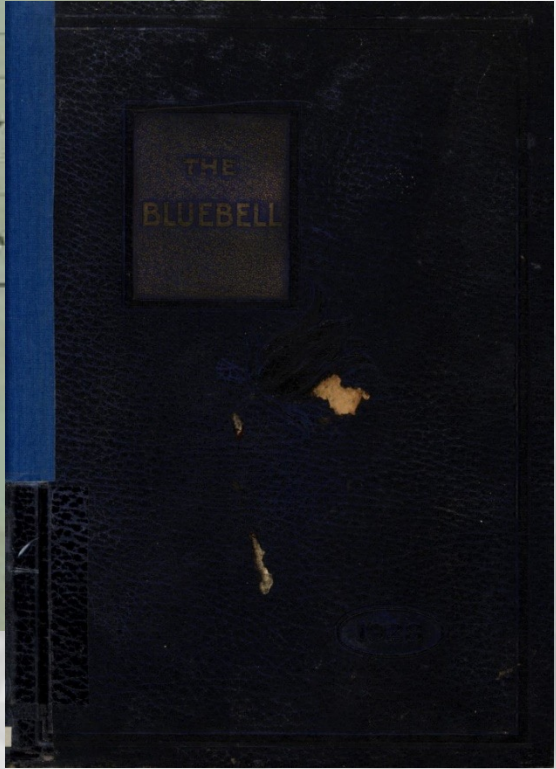
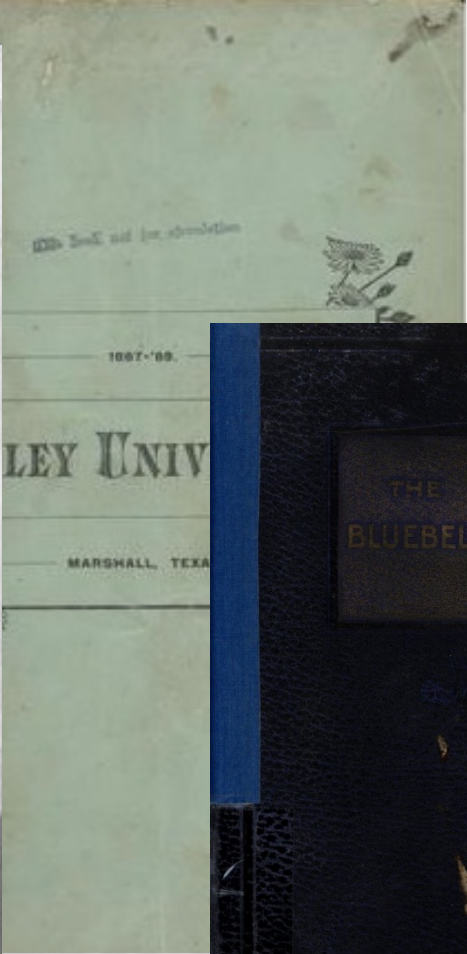
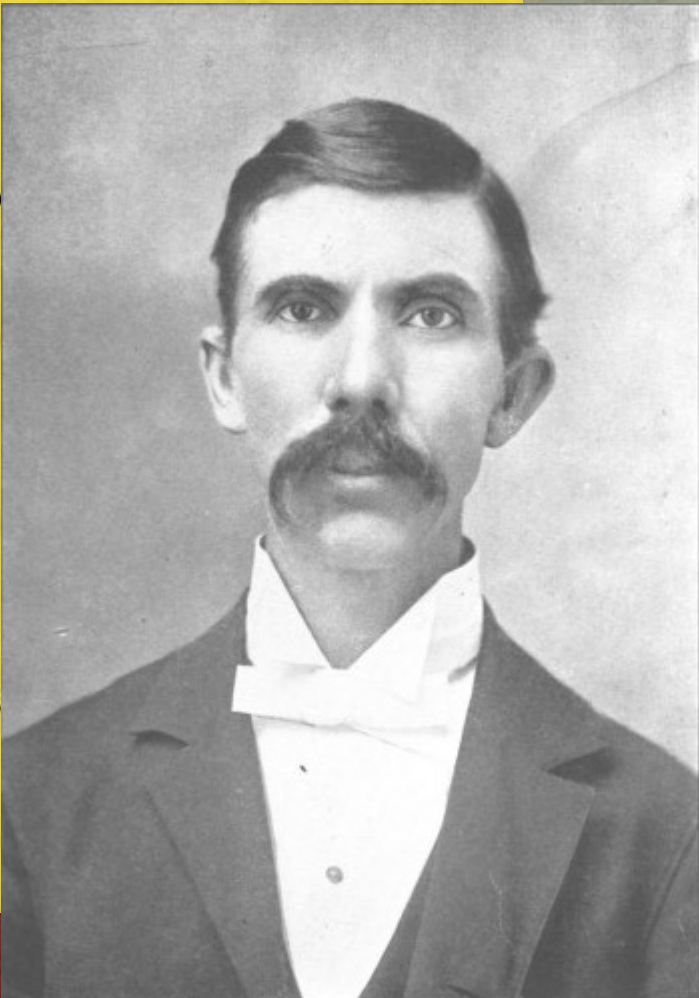
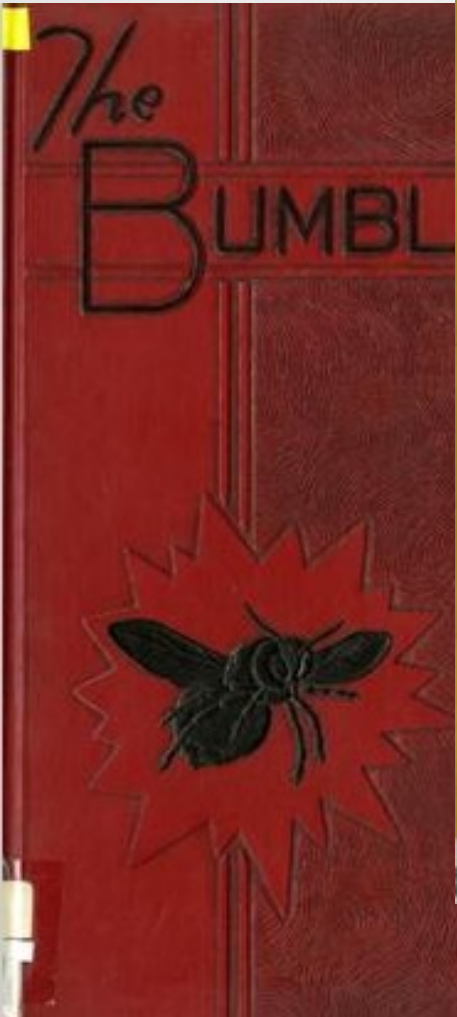

African American Funeral Programs of San Antonio

- 5,530 programs digitized
- 700 more to digitize
- 1930's to Present

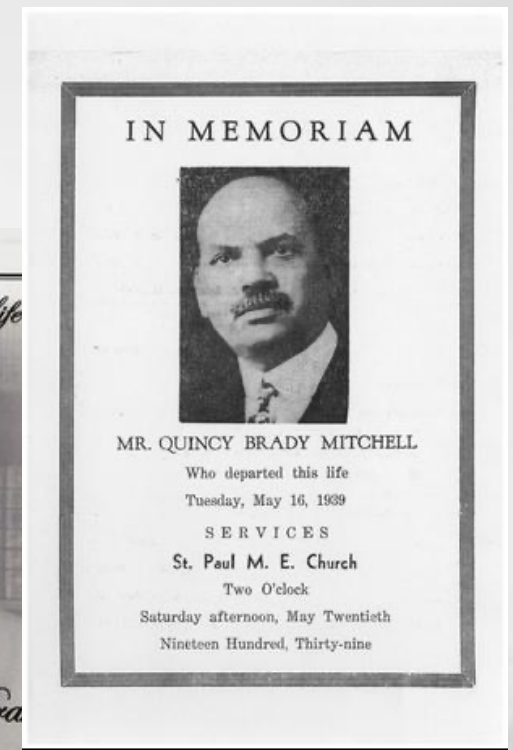
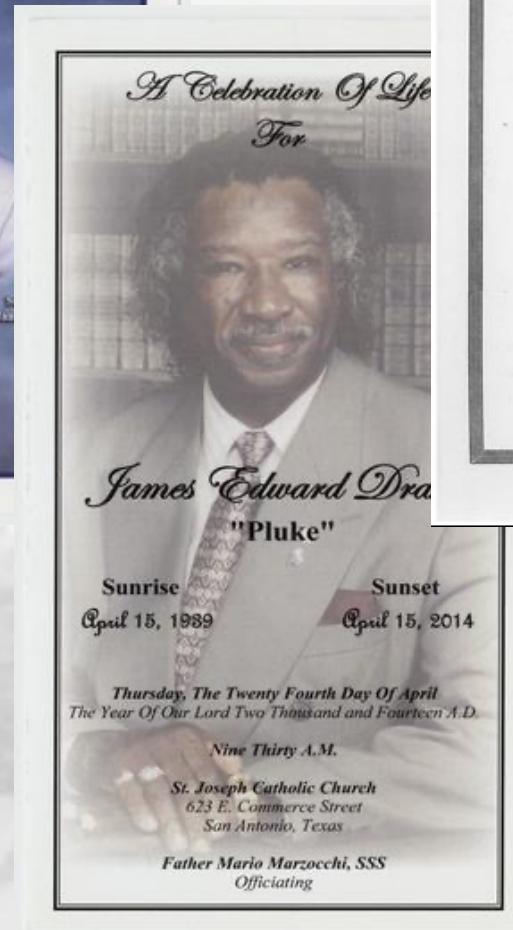
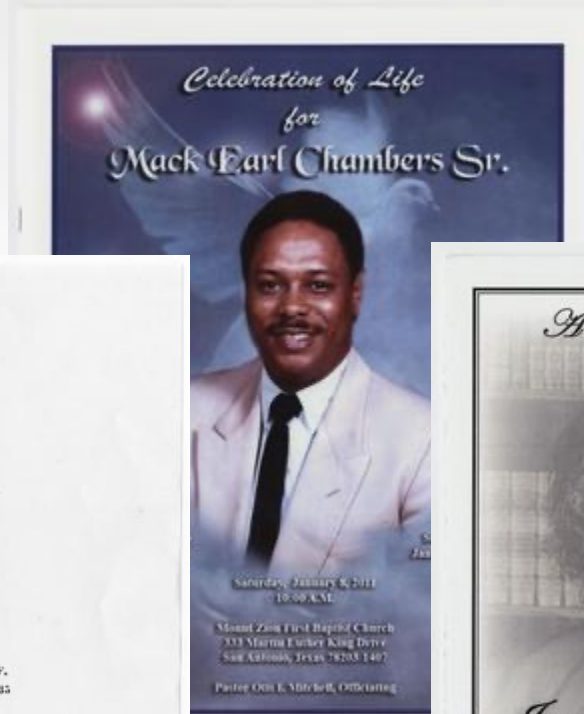
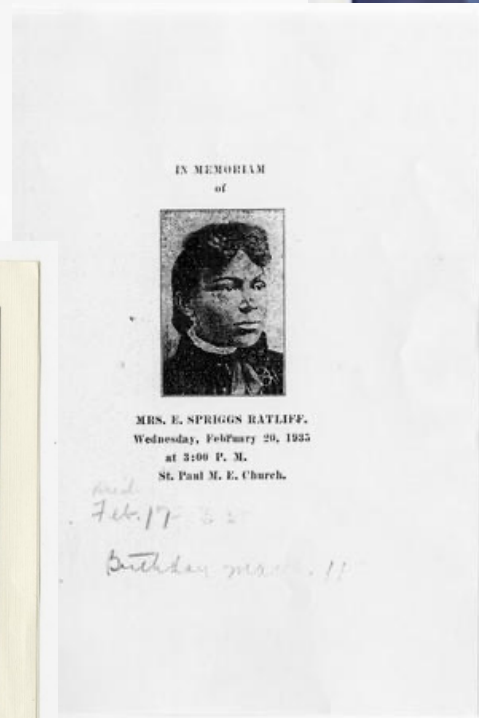

Correspondence Ledger of the Kempner Family

May 16th 4

I could possibly do
to give you a letter of
introduction to one of 2
banks. I know nothing of
special condition
such letter would do you
good at all of course
willing to give you such
letter

Mr E. H. Sewall
Dorchester
D. C.

The only way to get
money in N. Y. is to open
an acc with a bank
and they will give you
a line of discount
proportion to your daily
balances in other words
if your daily balances
amount to \$5 M they the

Correspondence Ledger of the Kempner Family

[Faint handwritten text, likely bleed-through from the reverse side of the page. The text is mostly illegible due to fading and bleed-through.]

Types of Information in Newspapers

- Births and deaths
- Marriage announcements
- Military service
- Land purchases
- Promotions
- Advertisements: Family businesses
- Travel announcements
- Social activities

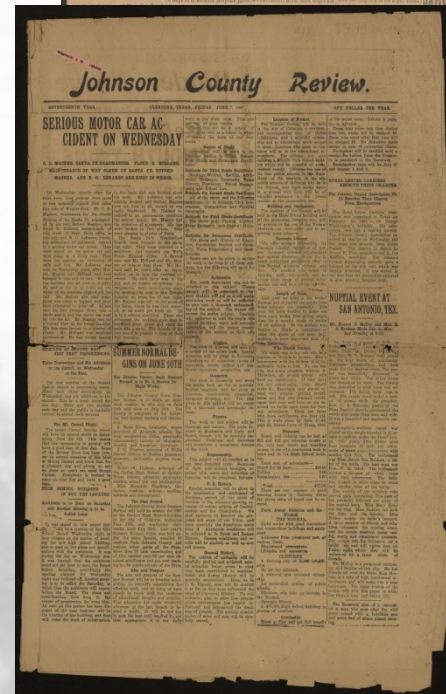

Texas Digital Newspaper Program

- Hosts newspapers from across Texas, with 1780 titles.
- Ever-growing: if you research something today and don't find it—check tomorrow!
- Spans 1813 to the present.
- Fully text-searchable.
- Some newspaper collections have materials from across the U.S.

878,504 Items	4 Types	1780 Titles
212 Partners	22 Decades	12 Languages
282 Counties	34 States	11 Countries
44,811,208 Usage	13 years, 11 months ago Collection Created	1 day, 14 hours ago Last Updated



Early Texas Newspaper Collection

- Earliest microfilmed newspapers held at UT's Dolph Briscoe Center for American History.
- Texas newspapers, spanning 1829-1950, with heavy coverage from 1840-1873.
- Digitized through support of an IMLS-funded TexTreasures grant, awarded through the Texas State Library & Archives Commission.



Searching in the Portal



1. Start a broad and then refine



The Portal to Texas History

Search 1,821,477 items from 471 partners across Texas.

Any Type ▾

Search

any **Sample Searches:**

"Stephen F. Austin"

"Brenham Daily Banner"

LGBT "March on Washington"

"National Park"

"Houston Post"

A gateway to rare, historical, and primary source materials from or about Texas.

About the Portal

Search ▾

Explore by ▾

Take a Tour

Donate

Plant History

Any Type ▾

🔍 Search

Washington"

"National Park"

"Houston Post"

Plant these in Sp

SPECIES

HEIGHT

Prairie Anagallis

2-3'

Available Filters

Partners	421
Collections	620
Serial/Series Titles	1,000+
Resource Types	36
World Regions	11
Countries	141
U.S. States	51
Counties	1379
Decades	51
Years	361
Months	12
Days	31
Languages	28

You Are Here: home / search / results

1,332,002 Matching Results

Your Search Terms:

Other Search Options ▾

Look In: Full Text ▾

Results: 1 - 24 of 1,332,002 next ▶



Sort: Date Added (Newest) ▾



The Ballinger Ledger (Ballinger, Tex.), Vol. 78, No. 44, Ed. 1 Thursday, April 22, 1965

Weekly newspaper from Ballinger, Texas that includes local, state, and national news along with advertising.

DATE: April 22, 1965

CREATOR: Perry, Richard H.

ITEM TYPE: Newspaper

PARTNER: Carnegie Library of Ballinger



Brenham Banner-Press (Brenham, Tex.), Vol. 44, No. 211, Ed. 1 Saturday, December 3, 1927

Daily newspaper from Brenham, Texas that includes local, state, and national news along



Available Filters

Partners	421
Collections	620
Serial/Series Titles	1,000+
Resource Types	36
World Regions	11
Countries	141
U.S. States	51
Counties	1379
Decades	51
Years	361
Months	12
Days	31
Languages	28

You Are Here: [home](#) / [search](#) / [results](#)

1,332,002 Matching Results

Your Search Terms:

[Other Search Options ▾](#)

Look In: [Full Text ▾](#) [Search](#)

Results: 1 - 24 of 1,332,002 [next ▶](#)



Sort: [Date Added \(Newest\) ▾](#)



The Ballinger Ledger (Ballinger, Tex.), Vol. 78, No. 44, Ed. 1 Thursday, April 22, 1965

Weekly newspaper from Ballinger, Texas that includes local, state, and national news along with advertising.

DATE: April 22, 1965

CREATOR: Perry, Richard H.

ITEM TYPE: Newspaper

PARTNER: Carnegie Library of Ballinger



Brenham Banner-Press (Brenham, Tex.), Vol. 44, No. 211, Ed. 1 Saturday, December 3, 1927

Daily newspaper from Brenham, Texas that includes local, state, and national news along



Available Filters

- Partners
- Collections
- Serial/Series Titles 1,000
- Resource Types
- World Regions
- Countries
- U.S. States
- Counties 11
- Decades
- Years
- Months
- Days
- Languages

Share



Filter: Decades

Having trouble finding an option within the list of Decades? Start typing and we'll update the list to show only those items that match your needs.

What are you looking for?

Sort Decades	Sort Count
2010-2019	119,277
2000-2009	88,899
1990-1999	81,527
1980-1989	102,292
1970-1979	93,809
1960-1969	118,499
1950-1959	97,500
1940-1949	94,565
1930-1939	76,150
1920-1929	68,397
1910-1919	96,473

You Are Here: home / search / results

Other Search Options

Book In: Full Text

Search

Sort: Date Added (Newest)

al, state, and national news

3, 1927

state, and national news along



Currently Limited To

Decade: 1940-1949



Clear All Filters

Available Filters

- Partners 263
- Collections 298
- Serial/Series Titles 689
- Resource Types 29
- World Regions 10
- Countries 53
- U.S. States 48
- Counties 513
- Years 10**
- Months 12
- Days 31
- Languages 13

You Are Here: home / search / results

94,565 Matching Results

Your Search Terms:

Other Search Options ▾

Look In: Full Text ▾

Search

Results: 1 - 24 of 94,565 next ▶



Sort: Date Added (Newest) ▾



The Lavaca County Tribune (Hallettsville, Tex.), Vol. 18, No. 48, Ed. 1 Tuesday, June 21, 1949

Semi-weekly newspaper from Hallettsville, Texas that includes local, state, and national news along with advertising.

DATE: June 21, 1949

CREATOR: Malec, Walter

ITEM TYPE: Newspaper

PARTNER: French Simpson Memorial Library



The Lavaca County Tribune (Hallettsville, Tex.), Vol. 18, No. 79, Ed. 1 Tuesday, October 11, 1949

Semi-weekly newspaper from Hallettsville, Texas that includes local, state, and national news along with advertising.

DATE: October 11, 1949

CREATOR: Malec, Walter



Currently Limited To

Decade: 1940-1949

Clear All Filters

Available Filters

- Partners
- Collections
- Serial/Series Titles
- Resource Types
- World Regions
- Countries
- U.S. States
- Counties
- Years
- Months
- Days
- Languages

Filter: Years

Sort Years	Sort Count
1949	9,137
1948	7,795
1947	7,211
1946	7,432
1945	10,160
1944	9,987
1943	10,071
1942	11,492
1941	11,398
1940	9,882

Close

You Are Here: home / search / results

Other Search Options

Search In: Full Text Search

Sort: Date Added (Newest)

1, 1949

les local, state, and national

r 11, 1949

les local, state, and national



news along with advertising.

DATE: October 11, 1949

CREATOR: Malec, Walter



Currently Limited To

Decade: 1940-1949

Year: 1943

Clear All Filters

- Available Filters**
- Partners
 - Collections
 - Serial/Series Titles
 - Resource Types
 - World Regions
 - Countries
 - U.S. States
 - Counties
 - Months
 - Days
 - Languages

Filter: Resource Types

Having trouble finding an option within the list of Resource Types? Start typing and we'll update the list to show only those items that match your needs.

What are you looking for?

Sort Resource Types Sort Count

Newspaper	5,561
Photograph	2,259
Text	850
Letter	364
Technical Drawing	209
Map	57
Journal/Magazine/Newsletter	53
Postcard	36
Book	28
Pamphlet	23

You Are Here: home / search / results

Other Search Options

Look In: Full Text

Sort: Date Added (Newest)

1943

al, state, and national news

al, state, and national news



Currently Limited To

Type: Newspaper x

Decade: 1940-1949 x

Year: 1943 x

Clear All Filters

Available Filters

Partners 89

Collections 104

Serial/Series Titles 108

U.S. States 2

Counties 73

Months 12

Days 31

Languages 3

Share



5,561 Matching Results

Your Search Terms:

Other Search Options

Search bar with 'Look In: Full Text' dropdown and 'Search' button.

Results: 1 - 24 of 5,561 next



Sort: Date Added (Newest)



The Wortham Journal (Wortham, Tex.), Vol. 44, No. 43, Ed. 1 Friday, February 26, 1943

Weekly newspaper from Wortham, Texas that includes local, state, and national news along with advertising.

- DATE:** February 26, 1943
- CREATOR:** Satterwhite, Ed
- PARTNER:** Fairfield Library



The Wortham Journal (Wortham, Tex.), Vol. 45, No. 9, Ed. 1 Friday, July 2, 1943

Weekly newspaper from Wortham, Texas that includes local, state, and national news along with advertising.

- DATE:** July 2, 1943



About This Issue

Overview

Who

What

When

Where

Search Inside

wortham journal 44



Matching Results

2

Read Now

Start Reading

Magnify First Page

Jump to...

Go

Show All Pages

4

Print & Share



Citations, Rights, Re-Use

Citing This Issue

Responsibilities of Use

The Wortham Journal (Wortham, Tex.), Vol. 44, No. 43, Ed. 1 Friday, February 26, 1943

One of 1,428 issues in the title: **The Wortham Journal** available on this site.

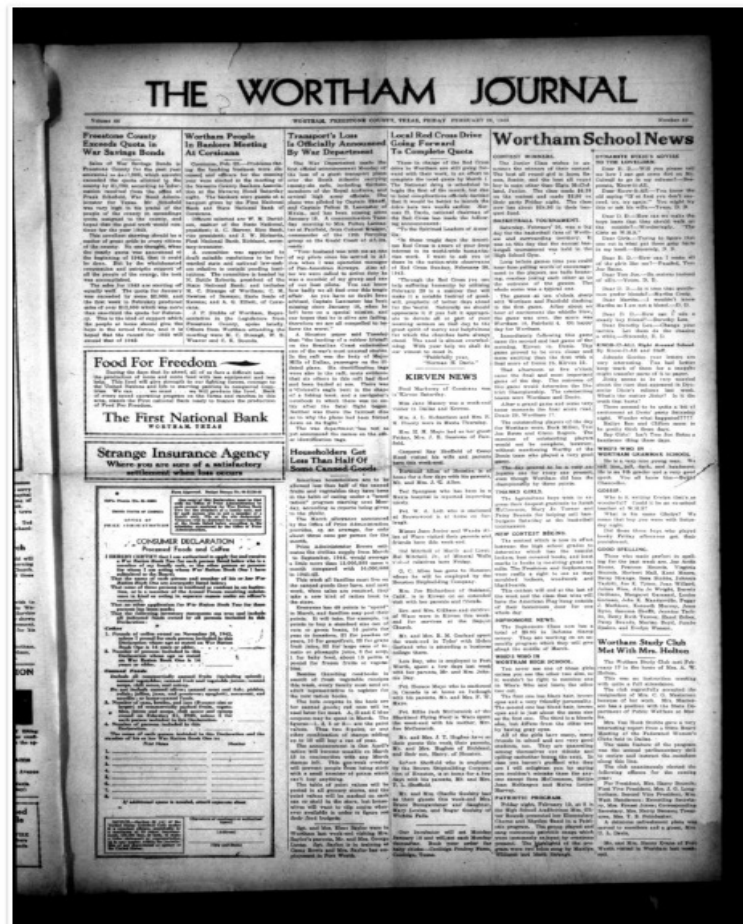

Description

Weekly newspaper from Wortham, Texas that includes local, state, and national news along with advertising.

Physical Description

four pages : ill. ; page 20 x 15 in. Digitized from 35 mm. microfilm.

Creation Information

Satterwhite, Ed February 26, 1943.

Context

This **newspaper** is part of the collection entitled: Freestone County Area Newspaper Collection and two others and was provided by Fairfield Library to The Portal to Texas History, a digital repository hosted by the UNT Libraries. More information about this issue can be viewed below.



Mapped



Search (2)



Who

People and organizations associated with either the creation of this newspaper or its content.

Editor

- [Satterwhite, Ed Ed. Satterwhite](#)

Publisher

- [Ed Satterwhite](#)

Publisher Info: Ed. Satterwhite

Place of Publication: Wortham, Texas

Audiences

 We've identified this **newspaper** as a **primary source** within our collections. Researchers, educators, and students may find this issue useful in their work.

Contact Us

[Corrections & Problems](#)[Questions](#)

Provided By

Fairfield Library

The Fairfield Library first opened its doors August 2, 1954, in a small brick house on the Courthouse square with just 224 books. In 1957, the library moved to the rear of the History Club clubhouse with hours from 4:00-5:30 Thursday afternoon. Through generous efforts from many families in the community and a donation of the Moody Grant Foundation, the Fairfield Library became a place where families could spend time together reading and enjoying the abundant resources.

[About](#) | [Browse this Partner](#)

About This Issue

Overview

Who

What

When

Where

Search Inside

wortham journal 44



Matching Results

2

Read Now

Start Reading

Magnify First Page

Jump to...

Go

Show All Pages

4

Print & Share



Citations, Rights, Re-Use

Citing This Issue

Responsibilities of Use

The Wortham Journal (Wortham, Tex.), Vol. 44, No. 43, Ed. 1 Friday, February 26, 1943

One of 1,428 issues in the title: **The Wortham Journal** available on this site.

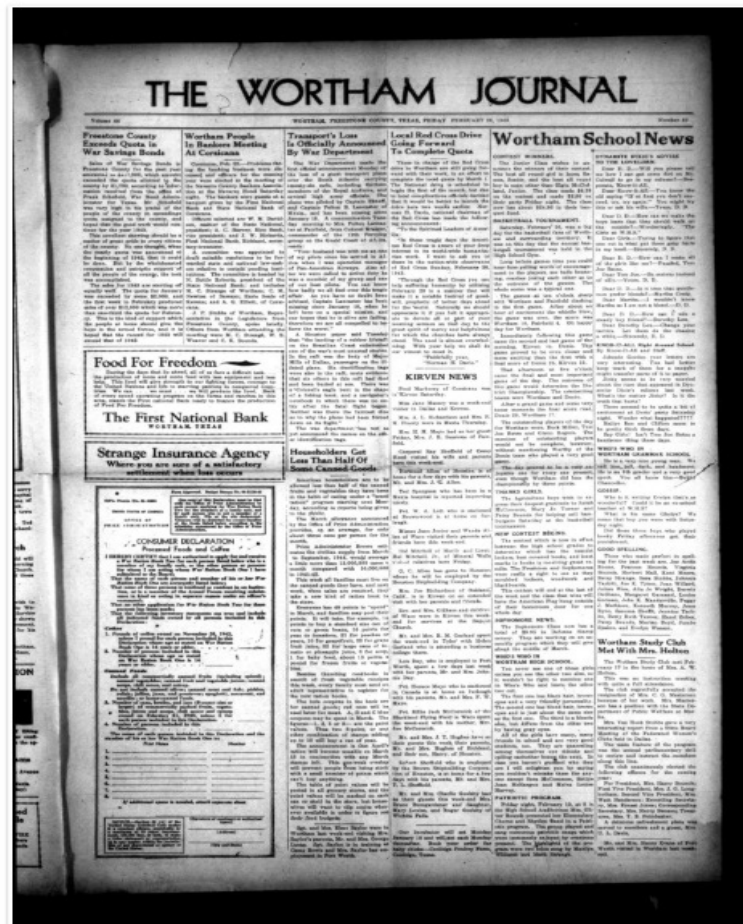

Description

Weekly newspaper from Wortham, Texas that includes local, state, and national news along with advertising.

Physical Description

four pages : ill. ; page 20 x 15 in. Digitized from 35 mm. microfilm.

Creation Information

Satterwhite, Ed February 26, 1943.

Context

This **newspaper** is part of the collection entitled: Freestone County Area Newspaper Collection and two others and was provided by Fairfield Library to The Portal to Texas History, a digital repository hosted by the UNT Libraries. More information about this issue can be viewed below.



Mapped



Search (2)



What

Descriptive information to help identify this newspaper. Follow the links below to find similar items on the Portal.

Titles

- **Main Title:** The Wortham Journal (Wortham, Tex.), Vol. 44, No. 43, Ed. 1 Friday, February 26, 1943
- **Serial Title:** [The Wortham Journal](#)

Description

Weekly newspaper from Wortham, Texas that includes local, state, and national news along with advertising.

Physical Description

four pages : ill. ; page 20 x 15 in.
Digitized from 35 mm. microfilm.

Notes

Published every Friday.

Subjects

Keyword

- [Wortham](#)

Library of Congress Subject Headings

- [Freestone County \(Tex.\) -- Newspapers.](#)

University of North Texas Libraries Browse Structure

- [Business, Economics and Finance -- Advertising](#)

Collections

This issue is part of the following collections of related materials.

Freestone County Area Newspaper Collection

The Freestone County Area Newspaper Collection spans eleven decades and represents five newspaper titles, include *The Fairfield Recorder*, *The Teague Chronicle*, *The Wortham Journal*, *The Bi-Stone Weekly Review*, and *The Streetman News*.

[About](#) | [Browse this Collection](#)

Tocker Foundation Grant

Collections funded by the Tocker Foundation, which distributes funds principally for the support, encouragement, and assistance to small rural libraries in Texas.

[About](#) | [Browse this Collection](#)

Texas Digital Newspaper Program

The Texas Digital Newspaper Program (TDNP)



About This Issue

Overview

Who

What

When

Where

Search Inside

wortham journal 44



Matching Results

2

Read Now

Start Reading

Magnify First Page

Jump to...

Go

Show All Pages

4

Print & Share



Citations, Rights, Re-Use

Citing This Issue

Responsibilities of Use

The Wortham Journal (Wortham, Tex.), Vol. 44, No. 43, Ed. 1 Friday, February 26, 1943

One of 1,428 issues in the title: **The Wortham Journal** available on this site.

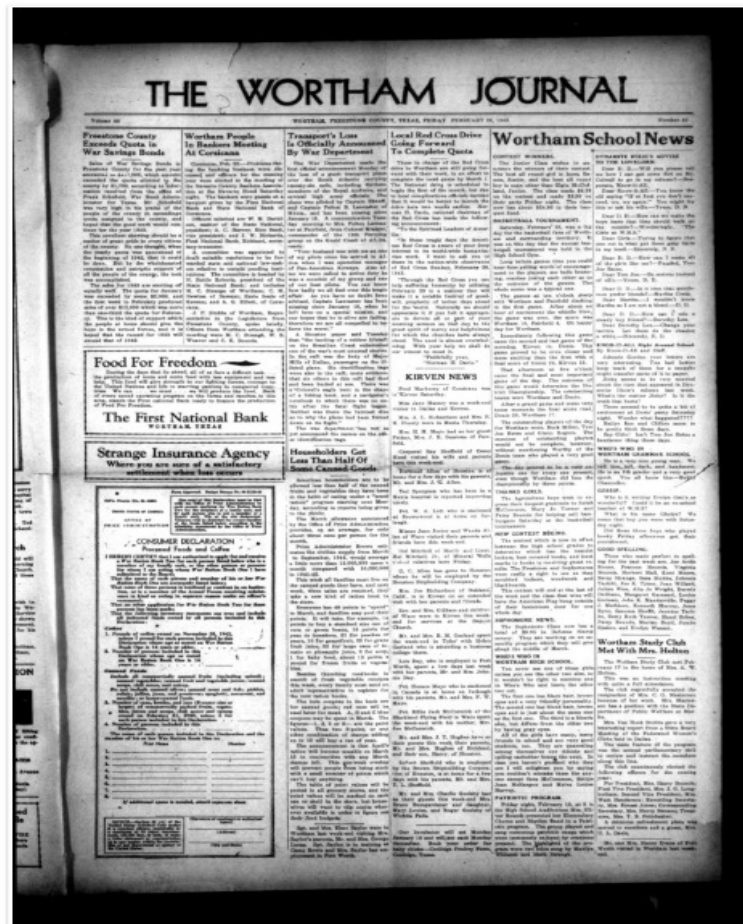

Description

Weekly newspaper from Wortham, Texas that includes local, state, and national news along with advertising.

Physical Description

four pages : ill. ; page 20 x 15 in. Digitized from 35 mm. microfilm.

Creation Information

Satterwhite, Ed February 26, 1943.

Context

This **newspaper** is part of the collection entitled: Freestone County Area Newspaper Collection and two others and was provided by Fairfield Library to The Portal to Texas History, a digital repository hosted by the UNT Libraries. More information about this issue can be viewed below.

Mapped

Search (2)



When

Dates and time periods associated with this newspaper.

Creation Date

- February 26, 1943

Covered Time Period

- [Into Modern Times, 1939-Present](#)

Added to The The Portal to Texas History

- Jan. 18, 2019, 10:14 p.m.

Usage Statistics

When was this issue last used?

Yesterday: 0

Past 30 days: 0

Total Uses: 2

[MORE STATISTICS](#)



About This Issue

- Overview
- Who
- What
- When
- Where

Search Inside

wortham journal 44



Matching Results

2

Read Now

Start Reading

Magnify First Page

Jump to...

Go

Show All Pages

4

Print & Share



Citations, Rights, Re-Use

Citing This Issue

Responsibilities of Use

The Wortham Journal (Wortham, Tex.), Vol. 44, No. 43, Ed. 1 Friday, February 26, 1943

One of 1,428 issues in the title: **The Wortham Journal** available on this site.

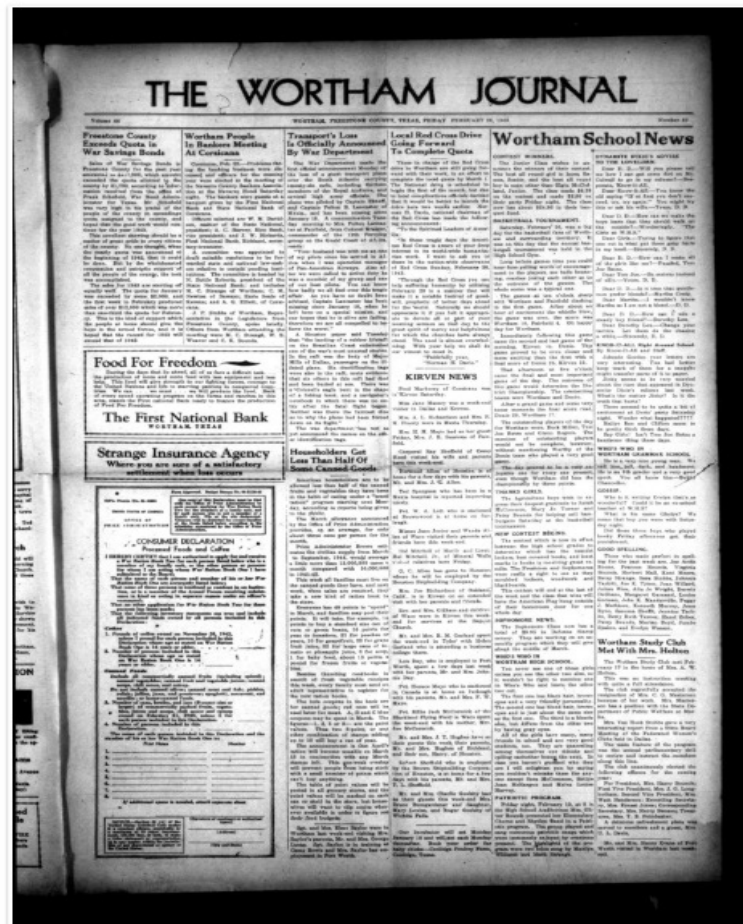

Description

Weekly newspaper from Wortham, Texas that includes local, state, and national news along with advertising.

Physical Description

four pages : ill. ; page 20 x 15 in. Digitized from 35 mm. microfilm.

Creation Information

Satterwhite, Ed February 26, 1943.

Context

This **newspaper** is part of the collection entitled: Freestone County Area Newspaper Collection and two others and was provided by Fairfield Library to The Portal to Texas History, a digital repository hosted by the UNT Libraries. More information about this issue can be viewed below.

Mapped

Search (2)



Where

Geographical information about where this newspaper originated or about its content.

Place Name

- United States - Texas - Freestone County - Wortham

Publication Place

- Wortham, Texas (Ed Satterwhite)

Map Information

Automatically generated Place Name coordinates.

Automatically generated Publication Place coordinates.

Relocating map may be required for optimal printing.

Mapped Locations

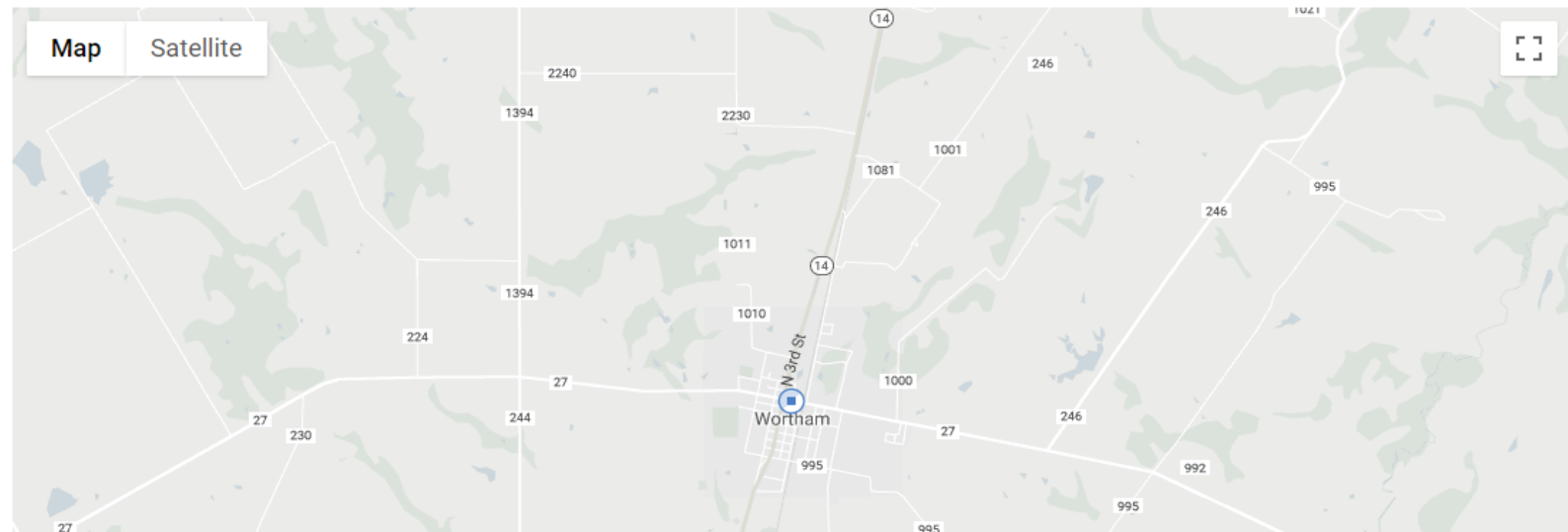

2. Keyword Searching

Search for an exact phrase by adding quotation marks around the phrase

“Dallas County”

“Probate Case”

“World War II”



The Portal to Texas History

Any Type ▾

 Search

Sample Searches: ["Fort Davis"](#) [County Courthouse](#) [LGBT "March on Washington"](#) ["Orange Leader"](#) ["El Paso Morning Times"](#)

A gateway to rare, historical, and primary source materials from or about Texas.

[About the Portal](#)

[Search](#) ▾

[Explore by](#) ▾

[Take a Tour](#)

[Donate](#)

The Portal

"Great War"]

Sample Searches:

"Fort Davis"

County Courthouse

LGBT "March"

21,821 Matching Results

Your Search Terms:

"Great War"

Other Search Options

Look In: Full Text

Search

Results: 1 - 24 of 21,821 next



Sort Options

Available Filters

Partners	227
Collections	372
Serial/Series Titles	806
Resource Types	17
World Regions	5
Countries	13
U.S. States	29
Counties	222
Decades	19
Years	175
Months	12
Days	31
Languages	6

Looking for Someone?

Your query contains a popular first

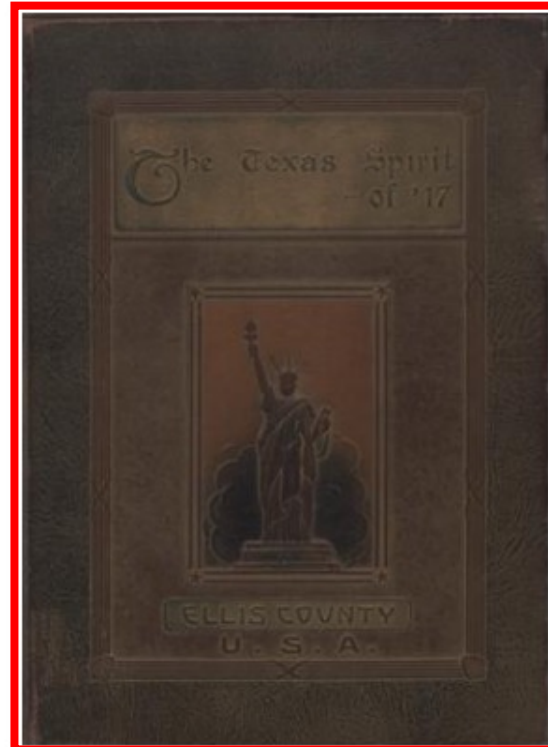
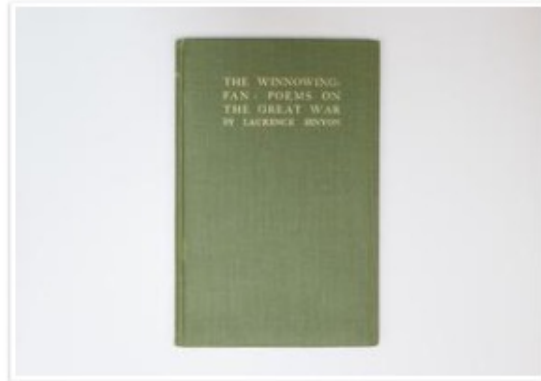

About This Book

- Overview
- Who
- What
- When
- Where

Search Inside

"great war"

Matching Results 6

Read Now

Start Reading

Magnify First Page

Jump to...

Show All Pages 177

Print & Share

-
-
-
-
-
-
-

Citations Rights Re-use

The Texas spirit of '17: a pictorial and biographical record of the gallant and courageous men from Ellis County who served in the Great War

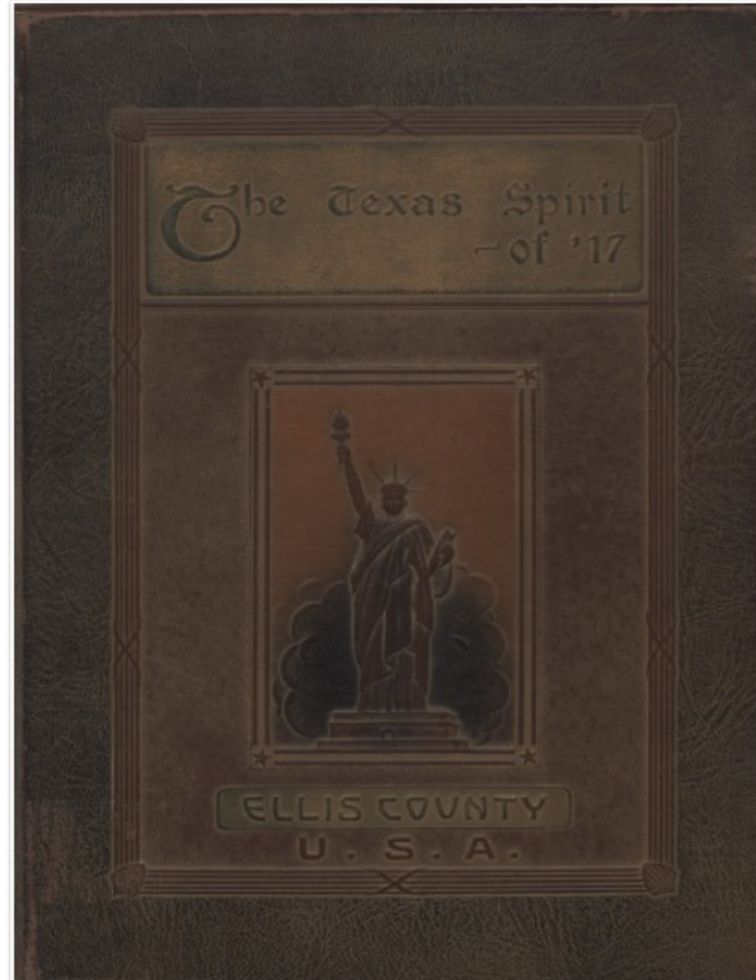

Description

Book that details the World War I military service of the citizens of Ellis County. Includes photographs and biographies.

Physical Description

197 p., [4] leaves of plates : ill. (some col.) ; 28 cm.

Creation Information

Army and Navy History Company. 1919.

Context

This book is part of the collection entitled: Texas History Collection and was provided by Tarrant County College NE, Heritage Room to The Portal to Texas History, a digital repository hosted by the UNT Libraries. It has been viewed 1967 times , with 17 in the last month . More information about this book can be viewed below.



About This Book

Overview

Who

What

When

Where

Search Inside

"great war" [Search]

Matching Results 6

Read Now

Start Reading

Magnify First Page

Jump to... [Go]

Show All Pages 177

Print & Share



You Are Here: home / search results / this book / searching inside

The Texas spirit of '17: a pictorial and biographical record of the gallant and courageous men from Ellis County who served in the Great War: Searching Inside

"great war" [Search Inside]

We Found:

6 results that matched your query.



Sequence: 126 (standard view) | zoom view



... service. This was the first official participation of the United States Navy in the **Great War**. The first

Improving Results

- Enclose phrases in quotation marks.
- Use alternate spellings.
- Limit or remove special characters and punctuation.

Unexpected/Odd Results?



Sequence: 98 (standard view) | zoom view

... in France served with his the high seas during the **Great War**, as his course of company. After the armistice



Sequence: 17 (standard view) | zoom view



Who
What
When
Where

Search Inside

"great war"

Matching Results 6

Read Now

Start Reading

Magnify This Page

Jump to...

Show All Pages 177

Print & Share

Citations, Rights, Re-Use

Citing This Book

Responsibilities of Use

Licensing & Permissions

Linking & Embedding

Copies & Reproductions

[Back to Search Results](#)

[View a full description of this book.](#)

search tools / download zoom



PRIVATE LUDIE W. JACKSON, son of Mr. and Mrs. S. H. Jackson, of Maypearl, was born in Ellis County, July 11, 1895. He finished his education at Fort Worth, Texas. The date of his entry into the service of his country was February 25, 1918. Private Jackson was attached to Company C, 357th Infantry, 90th Division. This Division received its training at Camp Travis, San Antonio, Texas. He was sent to France with his Division, June 20, 1918, and saw action in the battle of St. Mihiel, the first offensive conducted by all-American troops under American leadership, in which a salient occupied by the Germans for more than three years was taken by the Americans in less than two days in the advance on September 12, 1918. Private Jackson received a wound from a machine gun bullet in the left foot. Because of this wound he participated in no further action while in France. Private Jackson had been discharged from the Army, at the time of the collection of this data (August, 1919) and returned to civil life.



PRIVATE CHARLES MONROE WITHERSPOON, son of Mr. and Mrs. S. B. Witherspoon, of Midlothian, was born in Ellis County, August 26, 1897, and received his education in the public schools of Midlothian. He entered the service of his country July 22, 1918, and was attached to 34th Company, 165th Depot Brigade, which trained at Camp Travis. On September 25, 1918, Private Witherspoon was sent overseas, and while in France served with his company. After the armistice was signed, he was ordered to the United States and his discharge followed, after which he returned to civil life.



CLIFFORD SMITH WITHERSPOON, son of Mr. and Mrs. S. B. Witherspoon, of Midlothian, Texas, was born January 7, 1900, at Midlothian and it was here that he received his early education. Although only eighteen years of age, Mr. Witherspoon volunteered for service in the United States Navy, August 7, 1918, and was sent for training to the Naval Training Station at San Pedro, California. Signing of the armistice prevented his assignment to active duty on the high seas during the Great War, as his course of training had not yet been completed at that time. After receiving his discharge, he returned to civil life.



3. Browse by Subject



The Portal to Texas History

Search None items from 458 partners across Texas.

Any Type ▾

 Search

Sample Searches:

"Dallas Daily Herald"

"National Park"

"San Antonio Express"

"Texas Register"

"Telegraph and Texas Register"

A gateway to rare, historical, and primary source materials from or about Texas.

[About the Portal](#)

[Search](#) ▾

[Explore by](#) ▾

[Take a Tour](#)

[Donate](#)

l, and primary source material

al

Search



Explore by



Take a Tour

Do

Explore

[Overview](#)[Collections](#)[Partners](#)[Locations](#)[Subjects](#)[Types](#)[Dates](#)[Titles](#)

Explore Overview

The Portal to Texas History contains more than a half million items for you to explore.

463 Partners	729 Collections	8,496 Titles
37 Resource Types	1,082 Browseable Subjects	70 Decades
1,491 Counties	50 U.S. States	149 Countries

1 day, 2 hours ago
Last Updated



Collections

[View More Stats!](#)

o Texas History contains more than a half million items for you to explore.

463 Partners	729 Collections	8,496 Titles
37 Resource Types	1,082 Browsable Subjects	70 Decades
1,491 Counties	50 U.S. States	149 Countries

Explore

[Overview](#)[Collections](#)[Partners](#)[Locations](#)[Subjects](#)[Types](#)[Dates](#)[Titles](#)

Filter Subjects



The list of subjects will update as you type.

Top Level Terms

Show All[Agriculture](#)[Architecture](#)[Arts and Crafts](#)[Business, Economics and Finance](#)[Education](#)[Government and Law](#)

Explore 1,081 Subjects

◆ SUBJECT	◆ COUNT
Agriculture	2,520 items
Agriculture - Domestic Animals	5,974 items
Agriculture - Domestic Animals - Cattle	4,395 items
Agriculture - Domestic Animals - Donkeys	130 items
Agriculture - Domestic Animals - Goats	145 items
Agriculture - Domestic Animals - Horses	4,292 items
Agriculture - Domestic Animals - Horses - Tack	487 items
Agriculture - Domestic Animals - Mules	393 items
Agriculture - Domestic Animals - Poultry	696 items
Agriculture - Domestic Animals - Poultry - Turkeys	147 items
Agriculture - Domestic Animals - Sheep	248 items
Agriculture - Domestic Animals - Swine	260 items
Agriculture - Farm Equipment	2,049 items
Agriculture - Farm Equipment - Irrigation	150 items
Agriculture - Farm Equipment - Plows	689 items

Questions?



Thank you!

Look for us on Facebook and sign-up for our newsletter.



Resources from Other States

- **Chronicling America:** <http://chroniclingamerica.loc.gov>

“Chronicling America is a Website providing access to historic newspapers and select digitized newspaper pages and is produced by the National Digital Newspaper Program (NDNP). NDNP, a partnership between the National Endowment for the Humanities (NEH) and the Library of Congress (LC), is a long-term effort to develop an Internet-based, searchable database of U.S. newspapers with descriptive information and select digitization of historic pages.”

- **Gateway to Oklahoma History:** <http://gateway.okhistory.org>

Supported by UNT Libraries, the Gateway functions exactly like the Portal and is a resource for digital newspapers and photographs from Oklahoma history, spanning 1854-2006, and growing!



State Memory Project Listing

Library of Congress State Memory Projects:

<http://www.loc.gov/rr/program/bib/statememory/>

Links to primary source repositories across all fifty states. Different state projects vary, but each can be useful for enriching your understanding about your ancestors' lives.

The Library of Congress >> Researchers >> Virtual Programs & Services

 **Web Guides** VIRTUAL SERVICES
DIGITAL REFERENCE SECTION

[Home](#) >> [State Digital Resources](#) Find in [Virtual Services Web Pages](#)

State Digital Resources: Memory Projects, Online Encyclopedias, Historical & Cultural Materials Collections

Compiled by Christine A. Pruzin, Digital Reference Specialist

The Library of Congress [American Memory](#) project, [Primary Sources by State](#), [State Resource Guides](#), and other digital initiatives provide free access through the Internet to the treasures of the Library's collections that document America's history, culture, and creativity. Across the country, the archives, cultural institutions, museums, and libraries of many states are collaborating to create similar projects. They provide unprecedented access to materials that document local and regional growth and development as well as a look at the cultures and traditions that have made individual states and communities unique. The following is a compilation of state and regional digital projects and collaborations identified thus far. For each project, the primary institution or institutions overseeing the project are noted. The list will expand as new projects become available.

Please note that these links are provided as a convenience and for informational purposes only; they do not constitute an endorsement or an approval by the Library of Congress. The Library of Congress bears no responsibility for the accuracy, legality, or content of the external site, or for that of subsequent links. Contact the external site for answers to questions regarding its content.



[Rambles through our country - an instructive geographical game for the young](#)
New York: Schaefer & Weisenbach, Litho., c1890
1 print: chromolithograph
[Prints & Photographs Division](#)
Reproduction Number:
LC-DIG-pga-03272

[A](#) [C](#) [D](#) [E](#) [G](#) [H](#) [I](#) [K](#) [L](#) [M](#) [N](#) [O](#) [P](#) [R](#) [S](#) [T](#) [U](#) [V](#) [W](#) | [Multi-State](#) |

